

Leaflet Dispensers

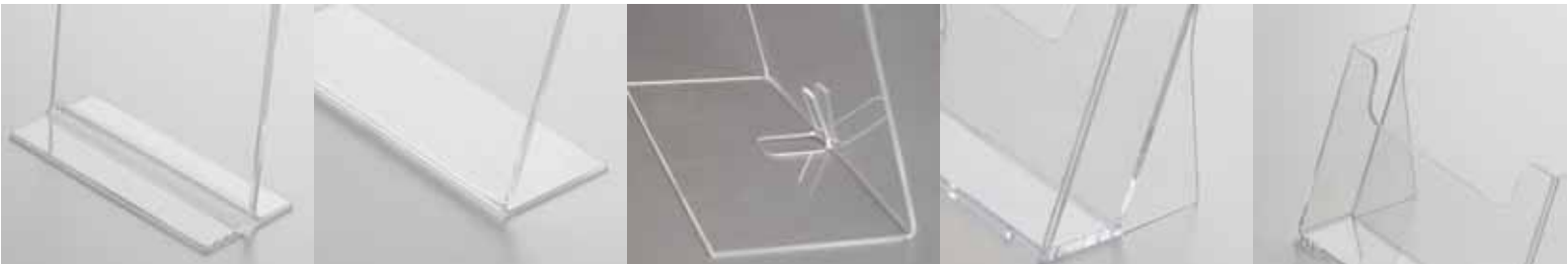

- Leaflet Dispensers
- Coloured Leaflet Dispensers
- Multiple Pocket Leaflet Dispensers
- Wall Mount Leaflet Dispensers
- Clear Brochure Holder T Type
- Clear Brochure Holder L Type
- Business Card Holder

Leaflet Dispensers

High resistant transparent clear document holders. Format A4 is suitable for displaying all types of documents such as catalogues, brochures, cards for every need, etc... These high quality injection moulded leaflet dispensers can be screen printed with logo on your request. Now it is ready with unit divider for A4 portrait into A4/3 size.

Silk Screen Printing on Leaflet Dispensers
 Minimum Pad Printing quantity is 200 pcs, please note the printing operations may extend the lead times. In each printing operation, a visual image of logo is requested as a FH9 or FH10 file. The maximum printing area on the dispenser is as follows:

MATERIAL : Clear		
SIZE	PRINTING SIZE	DESCRIPTION
1/3 A4	40 X 90 mm	Landscape
A5	55 X 140 mm	Landscape
A4	70 X 200 mm	Landscape



A4 Portrait



A5 Portrait



1/3 A4 Portrait

! Please handle with care during transportation.

1/3 A4 Size

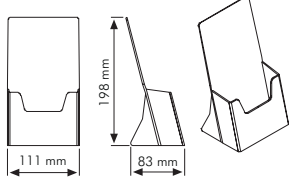

A5 Size

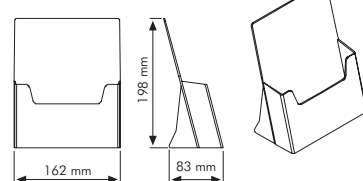

A4 Size

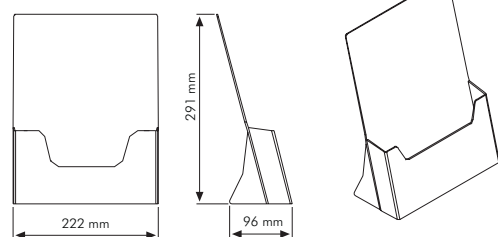

T SEPARATOR

ARTICLE
UYUP449601



T Separator

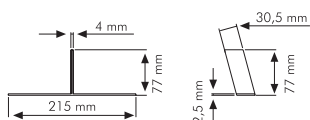

MATERIAL : Clear			WEIGHT	PACKING SIZE
ARTICLE	POSTER	DESCRIPTION	WITH PACKING	*W X H X D
UMSD001005	210 X 297 mm	A4 Portrait	8,350 kg	620 X 510 X 250 mm (20 pcs)
UMSD001004	148 X 210 mm	A5 Portrait	8,840 kg	790 X 350 X 240 mm (40 pcs)
UMSD001003	105 X 210 mm	1/3 A4 Portrait	7,350 kg	590 X 400 X 250 mm (50 pcs)

*W:Width H: Height D: Depth

Coloured leaflet dispensers are suitable to display all types of documents in corporate colours. Material is convenient for silk screen printing. RAL colour reference should be confirmed prior to production. For these custom coloured orders, you may receive up to 5% over or under quantities. Production time is 10 to 15 working days. Production starts only after receipt of approved colour confirmation.

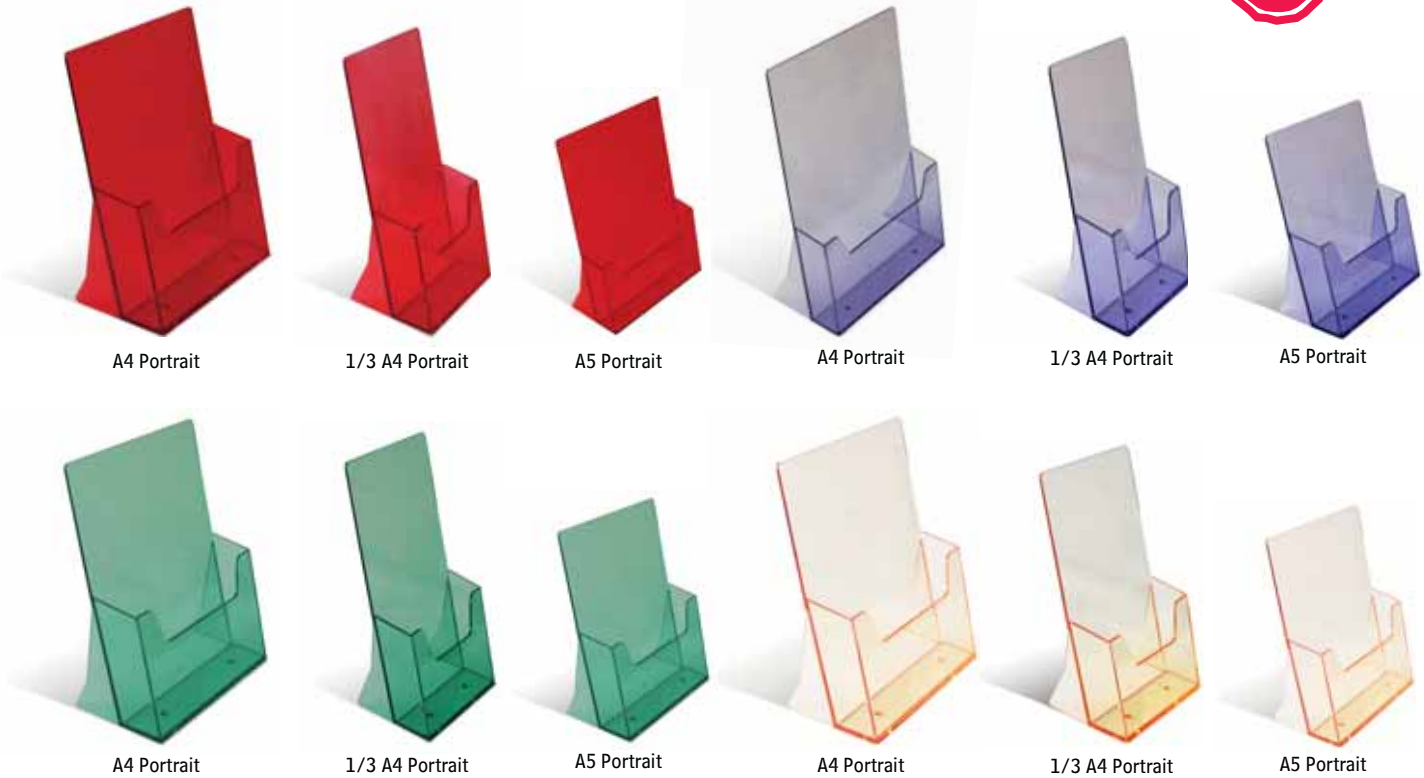

! Please handle with care during transportation.

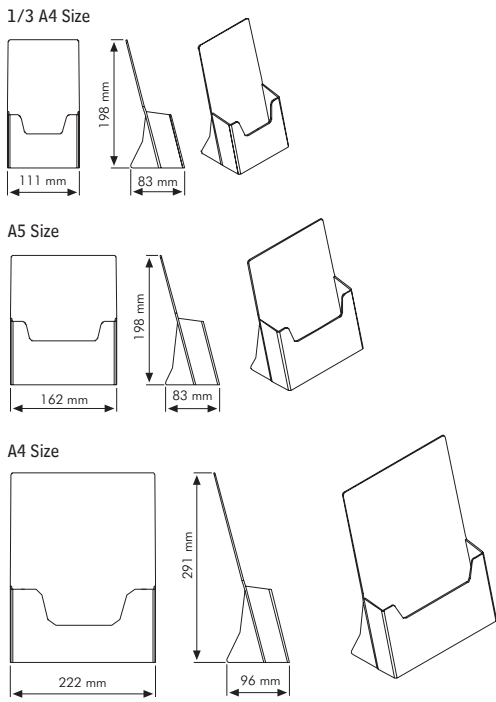

MATERIAL : Clear				WEIGHT	PACKING SIZE
ARTICLE	POSTER	DESCRIPTION	COLOUR	WITH PACKING	*W X H X D
UMSD001015	210 X 297 mm	A4 Portrait	Yellow	7,750 kg	620 X 510 X 250 mm (20 pcs)
UMSD001014	148 X 210 mm	A5 Portrait	Yellow	8,200 kg	790 X 350 X 240 mm (40 pcs)
UMSD001013	105 X 210 mm	1/3 A4 Portrait	Yellow	7,300 kg	590 X 400 X 250 mm (50 pcs)
UMSD001025	210 X 297 mm	A4 Portrait	Red	7,750 kg	620 X 510 X 250 mm (20 pcs)
UMSD001024	148 X 210 mm	A5 Portrait	Red	8,200 kg	790 X 350 X 240 mm (40 pcs)
UMSD001023	105 X 210 mm	1/3 A4 Portrait	Red	7,300 kg	590 X 400 X 250 mm (50 pcs)
UMSD001035	210 X 297 mm	A4 Portrait	Blue	7,750 kg	620 X 510 X 250 mm (20 pcs)
UMSD001034	148 X 210 mm	A5 Portrait	Blue	8,200 kg	790 X 350 X 240 mm (40 pcs)
UMSD001033	105 X 210 mm	1/3 A4 Portrait	Blue	7,300 kg	590 X 400 X 250 mm (50 pcs)
UMSD001045	210 X 297 mm	A4 Portrait	Purple	7,750 kg	620 X 510 X 250 mm (20 pcs)
UMSD001044	148 X 210 mm	A5 Portrait	Purple	8,200 kg	790 X 350 X 240 mm (40 pcs)
UMSD001043	105 X 210 mm	1/3 A4 Portrait	Purple	7,300 kg	590 X 400 X 250 mm (50 pcs)
UMSD001055	210 X 297 mm	A4 Portrait	Green	7,750 kg	620 X 510 X 250 mm (20 pcs)
UMSD001054	148 X 210 mm	A5 Portrait	Green	8,200 kg	790 X 350 X 240 mm (40 pcs)
UMSD001053	105 X 210 mm	1/3 A4 Portrait	Green	7,300 kg	590 X 400 X 250 mm (50 pcs)

Please contact with your sales executive for min order quantity.

* W:Width H: Height D: Depth

Multiple Pocket Leaflet Dispensers

High resistant transparent clear document holders. Dispensers can be screen printed with corporate logo. Our products are made of the finest materials, highest level of quality and clarity.



1/3 A4x4 Portrait



A4x3 Portrait



A5x3 Portrait



1/3 A4x3 Portrait

! Please handle with care during transportation.

1/3 A4x4 Portrait

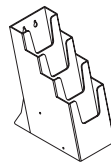
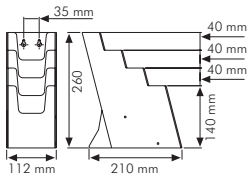

1/3 A4x3 Portrait

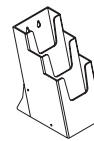
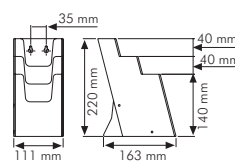

A5x3 Portrait

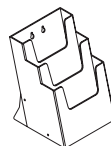
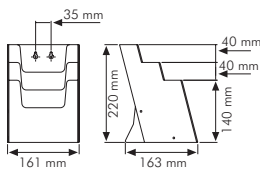

A4x3 Portrait

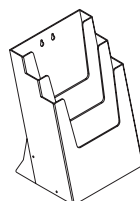
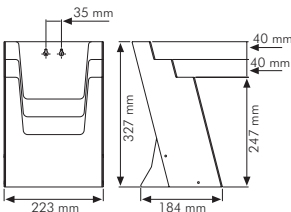

MATERIAL : Clear		
ARTICLE	POSTER	DESCRIPTION
UMSD003000	210 X 297 mm	A4x3 Portrait
UMSD003050	105 X 210 mm	1/3 A4x4 Portrait
UMSD004000	148 X 210 mm	A5x3 Portrait
UMSD005000	105 X 210 mm	1/3 A4x3 Portrait

* W:Width H: Height D: Depth

High resistant transparent clear document holders. They can be mounted in any convenient location. They come in 3 sizes and clear pocket is ideal for the display of menus, price lists, etc. These high quality brochure holders can be screen printed. All models are in stock and available for immediate shipment.

Silk Screen Printing on Wall Mount Leaflet Dispensers

Minimum pad printing quantity is 200 pcs, please note the printing operations may extend the lead time. In each printing operation, a visual image of the logo is requested as a FH9 or FH10 file. The maximum printing area on the wall mount dispensers is as follows:

MATERIAL : Clear		
SIZE	PRINTING SIZE	DESCRIPTION
1/3 A4	60 X 90 mm	Portrait
A5	60 X 140 mm	Portrait
A4	60 X 200 mm	Portrait



A4 Size

A5 Size

1/3 A4 Size

! Please handle with care during transportation.

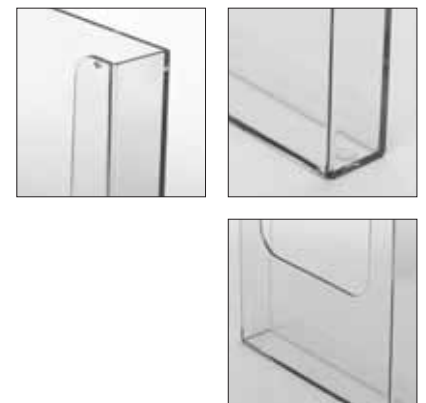
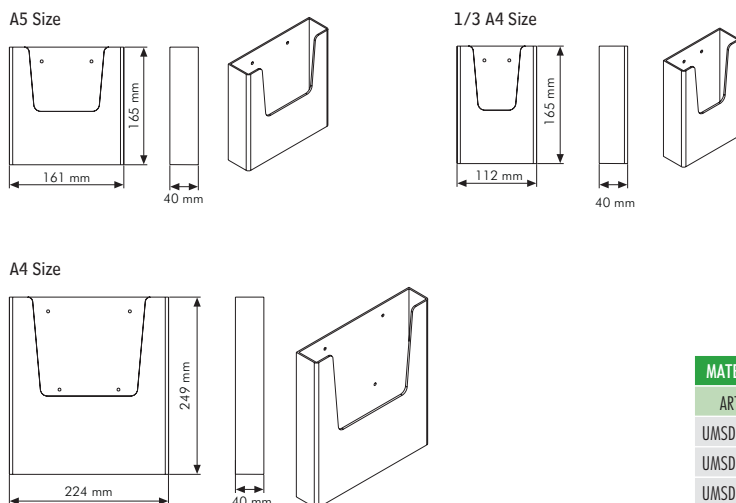

MATERIAL : Clear			WEIGHT	PACKING SIZE
ARTICLE	POSTER	DESCRIPTION	WITH PACKING	*W X H X D
UMSD008000	210 X 297 mm	A4 Portrait	11,000 kg	650 X 520 X 245 mm (30 pcs)
UMSD007000	148 X 210 mm	A5 Portrait	6,000 kg	650 X 500 X 180 mm (45 pcs)
UMSD006000	105 X 210 mm	1/3 A4 Portrait	12,000 kg	650 X 470 X 180 mm (60 pcs)

* W: Width H: Height D: Depth

Clear Brochure Holder L Type

High resistant transparent clear document holders. Ideal for the display of menus at the restaurants, price lists, etc... These high quality clear brochure holders can be screen printed with corporate logo. Non standard sizes can be produced to customer specification & needs; for printing and quantities please contact our sales executives.



! Please handle with care during transportation.

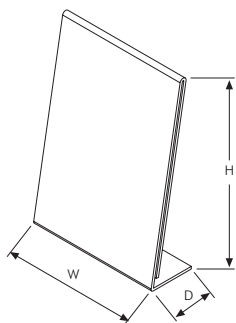
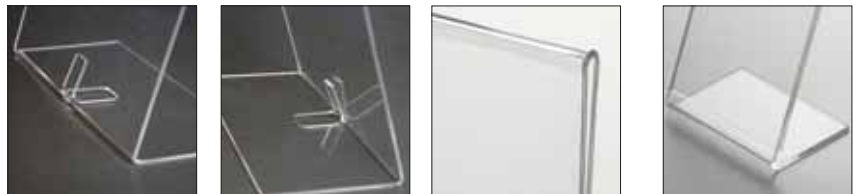

MATERIAL : Clear						WEIGHT	PACKING SIZE
ARTICLE	POSTER	DESCRIPTION	W	H	D	WITH PACKING	*W X H X D
UMSLD01000	210 X 297 mm	A4 Portrait	210	305	92	12,100 kg	255 X 325 X 440 mm (40 pcs)
UMSLY01000	297 X 210 mm	A4 Landscape	300	215	92	14,420 kg	300 X 315 X 340 mm (40 pcs)
UMSLD02000	148 X 210 mm	A5 Portrait	150	215	72	12,000 kg	270 X 405 X 370 mm (80 pcs)
UMSLY02000	210 X 148 mm	A5 Landscape	210	155	72	9,300 kg	240 X 265 X 480 mm (60 pcs)
UMSLD03000	105 X 148 mm	A6 Portrait	105	155	72	12,500 kg	270 X 405 X 370 mm (140 pcs)
UMSLY03000	148 X 105 mm	A6 Landscape	150	110	52	9,300 kg	240 X 265 X 480 mm (120 pcs)
UMSLD04000	105 X 210 mm	1/3 A4 Portrait	105	215	72	11,750 kg	270 X 405 X 370 mm (120 pcs)
UMSLY04000	210 X 105 mm	1/3 A4 Landscape	210	110	62	9,000 kg	240 X 265 X 480 mm (90 pcs)

* W:Width H: Height D: Depth

High resistant transparent clear document holders. Ideal for the display of menus at the restaurants, price lists, etc... These high quality clear brochure holders can be screen printed with corporate logo. Non standard sizes can be produced to customer specification & needs; for printing and quantities please contact our sales executives.



A6 portrait

1/3 A4 portrait

A4 portrait

A6 landscape

A5 landscape

! Please handle with care during transportation.

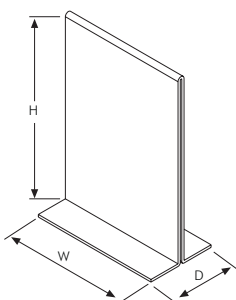

MATERIAL : Clear						WEIGHT	PACKING SIZE
ARTICLE	POSTER	DESCRIPTION	W	H	D	WITH PACKING	*W X H X D
UMSTD01000	210 X 297 mm	A4 Portrait	210	302	105	15,200 kg	485 X 485 X 350 mm (40 pcs)
UMSTY01000	297 X 210 mm	A4 Landscape	300	212	105	16,200 kg	630 X 485 X 370 mm (40 pcs)
UMSTD02000	148 X 210 mm	A5 Portrait	150	212	75	10,250 kg	575 X 515 X 260 mm (60 pcs)
UMSTY02000	210 X 148 mm	A5 Landscape	210	152	75	10,350 kg	575 X 515 X 260 mm (60 pcs)
UMSTD03000	105 X 148 mm	A6 Portrait	105	152	75	8,200 kg	425 X 460 X 260 mm (100 pcs)
UMSTY03000	148 X 105 mm	A6 Landscape	150	107	75	9,500 kg	485 X 485 X 350 mm (100 pcs)
UMSTD04000	105 X 210 mm	1/3 A4 Portrait	105	212	75	9,200 kg	425 X 460 X 260 mm (80 pcs)
UMSTY04000	210 X 105 mm	1/3 A4 Landscape	210	107	75	9,120 kg	425 X 460 X 260 mm (80 pcs)

*W:Width H: Height D: Depth

Business Card Holder

Clear Business Card Holder is good to organise your business, is perfect tool for professional appearance. This card holder is available in stock, ready to ship, boxed in 40's.



! Please handle with care during transportation.

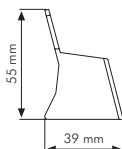
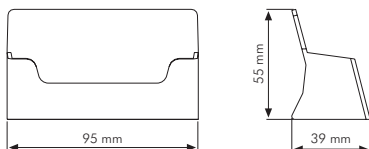
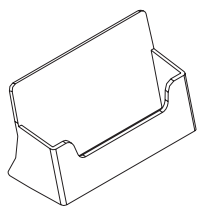
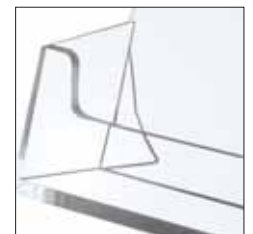

MATERIAL : Clear	WEIGHT	PACKING SIZE
ARTICLE	WITH PACKING	*W X H X D
UMSD009000	1,260 kg	250 X 350 X 90 mm (40 pcs)

* W:Width H: Height D: Depth