

Noticeboards



- Noticeboard With Cork
- Magnetic Noticeboard
- M&C Noticeboard
- Free Standing Noticeboard Single Leg
 - Noticeboard With Cork
 - Magnetic Noticeboard
 - M&C Noticeboard
- Free Standing Noticeboard Double Leg
 - Noticeboard With Cork
 - Magnetic Noticeboard
 - M&C Noticeboard



Noticeboard with Cork

Suitable for outdoor use. 4x A4, 6x A4, 9x A4, 12x A4 paper capacity sizes are available. Noticeboard can be used both in portrait and landscape positions. Each unit includes a free set of pins or magnets. The profile width is 70 mm and the depth of the case 50 mm.



100% WATERPROOF



-  Each product includes 2 mounting arms, 1 key set single variation & fixing set.
-  Each unit comes with a free set of pins. 2 handles at each end help to keep the cover door open.
-  Please throw away the silicagel on the cork once the unit is opened. Please do not drill the product while mounting, only use the mounting arms. Please throw away the protection film on the unit before use.

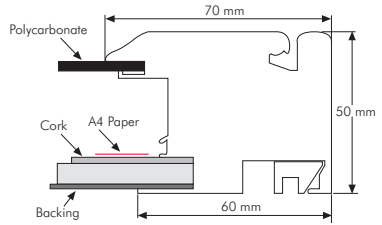
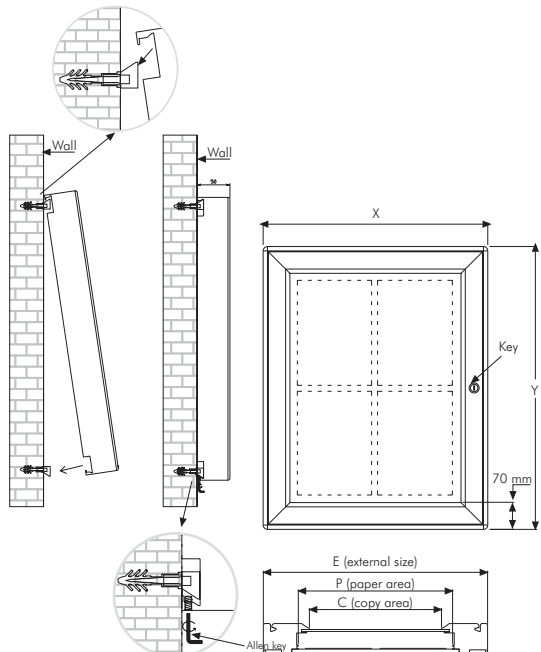

MATERIAL : Silver anodised aluminium					WEIGHT	PACKING SIZE
ARTICLE	EXTERNAL (x-y)	PAPER AREA	COPY	CAPACITY	WITH PACKING	*W X H X D
UNBN0004A4	590 X 760 mm	483 X 653 mm	450 X 620 mm	4 X A4	8,500 kg	620 X 780 X 80 mm
UNBN0006A4	590 X 1080 mm	483 X 973 mm	450 X 940 mm	6 X A4	11,250 kg	620 X 1100 X 80 mm
UNBN0009A4	820 X 1080 mm	713 X 973 mm	680 X 940 mm	9 X A4	14,600 kg	850 X 1100 X 80 mm
UNBN0012A4	1050 X 1080 mm	943 X 973 mm	910 X 940 mm	12 X A4	18,300 kg	1080 X 1100 X 80 mm



* W: Width H: Height D: Depth

Suitable for outdoor use. 4x A4, 6x A4, 9x A4, 12x A4 paper capacity sizes are available. Noticeboard can be used both in portrait and landscape positions. Each unit includes a free set of pins or magnets. The profile width is 70 mm and the depth of the case 50 mm.



100% WATERPROOF



 Each product includes 2 mounting arms, 1 key set single variation & fixing set.

 Each unit comes with a free set of magnets. 2 handles at each end help to keep the cover door open.

 Please do not drill the product while mounting, only use the mounting arms. Please throw away the protection film on the unit before use.

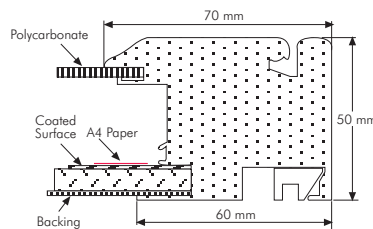
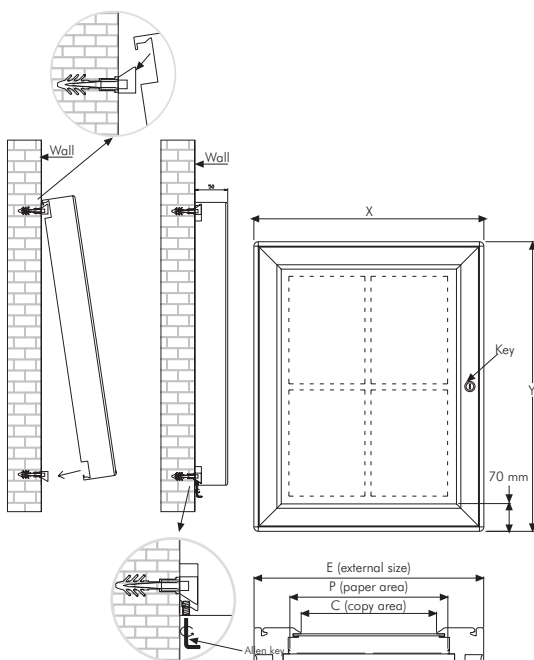

MATERIAL : Silver anodised aluminium					WEIGHT	PACKING SIZE
ARTICLE	EXTERNAL (x-y)	PAPER AREA	COPY	CAPACITY	WITH PACKING	*W X H X D
UNBN1004A4	590 X 760 mm	483 X 653 mm	450 X 620 mm	4 X A4	9,750 kg	620 X 780 X 80 mm
UNBN1006A4	590 X 1080 mm	483 X 973 mm	450 X 940 mm	6 X A4	13,340 kg	620 X 1100 X 80 mm
UNBN1009A4	820 X 1080 mm	713 X 973 mm	680 X 940 mm	9 X A4	17,600 kg	850 X 1100 X 80 mm
UNBN1012A4	1050 X 1080 mm	943 X 973 mm	910 X 940 mm	12 X A4	22,220 kg	1080 X 1100 X 80 mm



* W: Width H: Height D: Depth

Suitable for outdoor use. It has a cork backing & a perforated steel backing that allows the use of both magnet buttons & pins for cork together. Single key 4xA4, double key 6xA4, 9xA4 and 12xA4 sizes are available.



Each product includes 2 mounting arms, 1 key set single variation & fixing set.

Each unit comes with a free set of pins & magnets. 2 handles at each end help to keep the cover door open.

Please throw away the silicagel on the cork once the unit is opened. Please do not drill the product while mounting, only use the mounting arms. Please throw away the protection film on the unit before use.

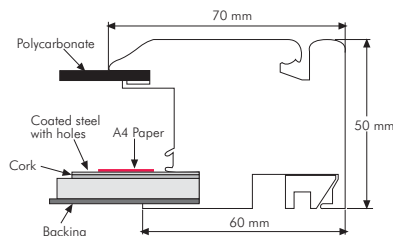
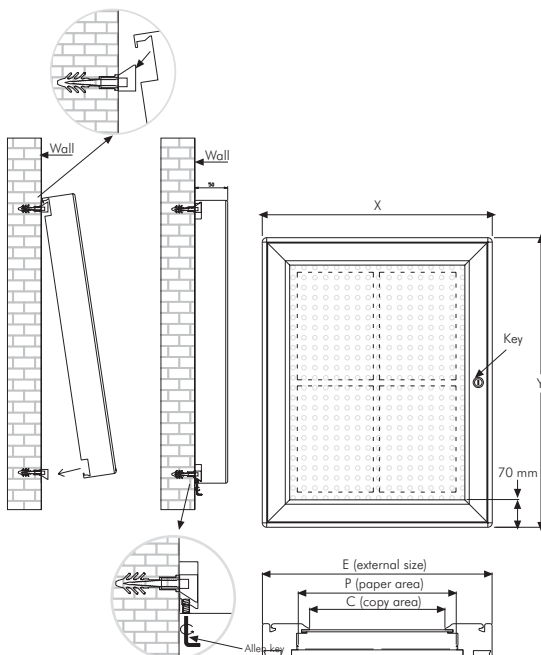

MATERIAL : Silver anodised aluminium					WEIGHT	PACKING SIZE
ARTICLE	EXTERNAL (x-y)	PAPER AREA	COPY	CAPACITY	WITH PACKING	*W X H X D
UNBN2004A4	590 X 760 mm	483 X 653 mm	450 X 620 mm	4 X A4	9,750 kg	620 X 780 X 80 mm
UNBN2006A4	590 X 1080 mm	483 X 973 mm	450 X 940 mm	6 X A4	13,300 kg	620 X 1100 X 80 mm
UNBN2009A4	820 X 1080 mm	713 X 973 mm	680 X 940 mm	9 X A4	17,600 kg	850 X 1100 X 80 mm
UNBN2012A4	1050 X 1080 mm	943 X 973 mm	910 X 940 mm	12 X A4	21,450 kg	1080 X 1100 X 80 mm



* W: Width H: Height D: Depth

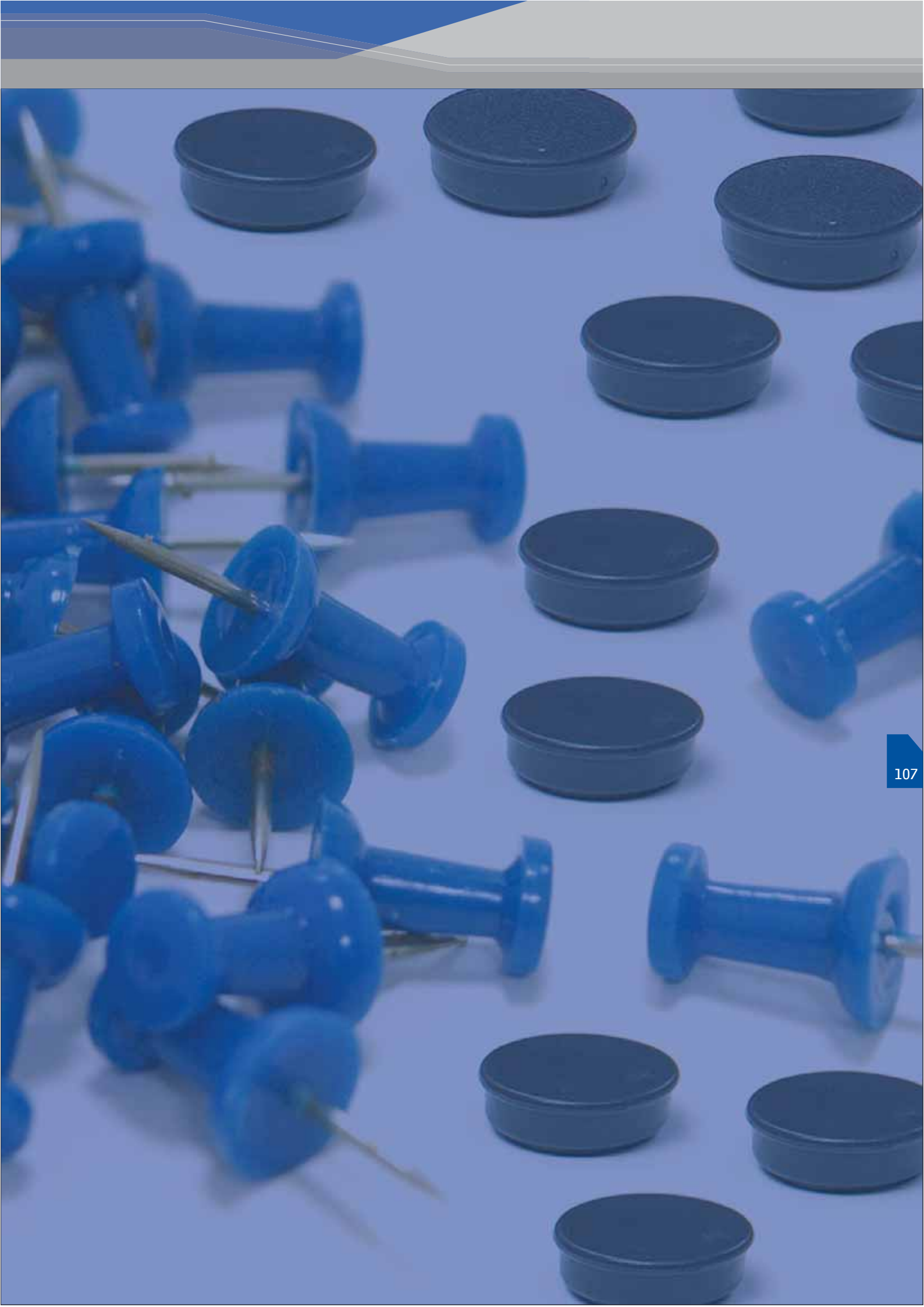



Single Leg Noticeboards

Height is 1920 mm. Single key 4x4, double key 6x4, 9x4 and 12x4 sizes are available. It has 3 different backing models. Clear acrylic shelves and steel shelves can be added if desired.



 Each product includes connector at the back & 1 key set of single variation.

 Each unit comes with a free set of pins or magnets. 2 handles at each side help to keep the cover door open.

 Please throw away the silicagel on the cork once the unit is opened. Please throw away the protection film on the unit before use.



Noticeboard with Cork



Magnetic Noticeboard



M&C Noticeboard

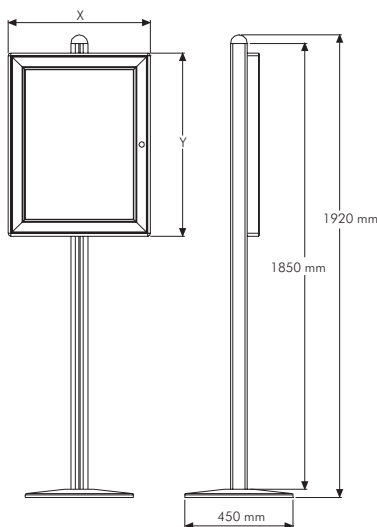

MAIN BODY : Silver anodised aluminium
ARTICLE
 UFSL001000

MATERIAL : Silver anodised aluminium					WEIGHT WITH PACKING			PACKING SIZE
NOTICEBOARD WITH CORK	MAGNETIC NOTICEBOARD	M&C NOTICEBOARD	EXTERNAL (x-y)	CAPACITY	NOTICEBOARD WITH CORK	MAGNETIC NOTICEBOARD	M&C NOTICEBOARD	*W X H X D
UFSL050000	UFSL055000	UFSL060000	590 X 760 mm	4 X A4	8,700 kg	9,750 kg	9,750 kg	620 X 780 X 80 mm
UFSL051000	UFSL056000	UFSL061000	590 X 1080 mm	6 X A4	11,250 kg	12,900 kg	12,900 kg	620 X 1100 X 80 mm



* W:Width H: Height D: Depth



Height is 1760 mm. Single key 4xA4, double key 6xA4, 9xA4 and 12xA4 sizes are available. It has 3 different backing models. Single or double sided shelves can be added and 4 pieces wheel can be added if desired.





Noticeboard with Cork



Magnetic Noticeboard

 Each product is packed with unassembled legs, including the fixing set & 1 key set of single variation.

 Each unit comes with a free set of pins or magnets. 2 handles at each side help to keep the cover door open.

 Please throw away the silicagel on the cork once the unit is opened. Please throw away the protection film on the unit before use.



M&C Noticeboard

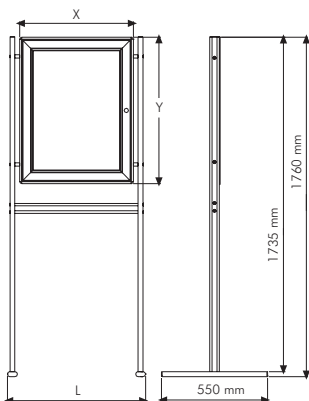

MATERIAL : Silver anodised aluminium						WEIGHT WITH PACKING			PACKING SIZE
NOTICEBOARD WITH CORK	MAGNETIC NOTICEBOARD	M&C NOTICEBOARD	EXTERNAL (x-y)	L	CAPACITY	NOTICEBOARD WITH CORK	MAGNETIC NOTICEBOARD	M&C NOTICEBOARD	*W X H X D
UIB800TN44	UIB810TN44	UIB820TN44	590 X 760 mm	715 mm	4 X A4	14,475 kg	15,600 kg	15,600 kg	700 X 1780 X 95 mm
UIB800TN64	UIB810TN64	UIB820TN64	590 X 1080 mm	715 mm	6 X A4	16,620 kg	18,700 kg	18,700 kg	700 X 1780 X 95 mm
UIB800TN94	UIB810TN94	UIB820TN94	820 X 1080 mm	945 mm	9 X A4	19,470 kg	21,600 kg	23,200 kg	940 X 1780 X 95 mm



* W:Width H: Height D: Depth

