

Showboards

Showboards



- Poster Showboard
- Showboard With Cork
- Magnetic Showboard
- M&C Showboard
- Felt Showboard
- Office Board
- Free Standing Showboard
Single Leg
 - Poster Showboard
 - Showboard With Cork
 - Magnetic Showboard
 - M&C Showboard
- Free Standing Showboard
Double Leg
 - Poster Showboard
 - Showboard With Cork
 - Magnetic Showboard
 - M&C Showboard

Poster Showboard

Suitable for out door use. Single key A2, A3, double key A1, A0, 500x700 mm, 700x1000 mm sizes are available. The cover can be opened 90 degrees. Each unit includes mounting screws and dobels. The profile width is 45 mm and the depth of the case 30 mm.



Each product includes 1 key set of single variation.

Each unit comes with a free set of clear plastic pegs to hold the poster. 2 handles at each end help to keep the cover door open.

Please throw away the protection film on the unit before use.

100% WATERPROOF

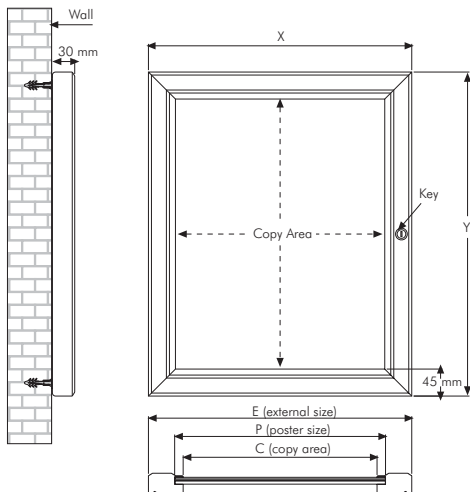
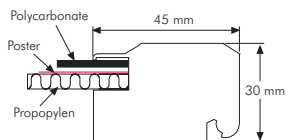
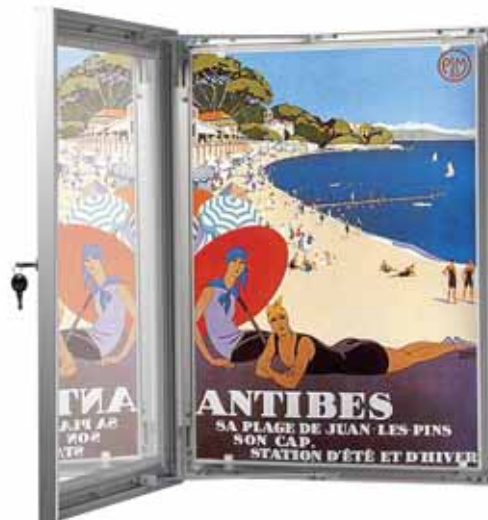
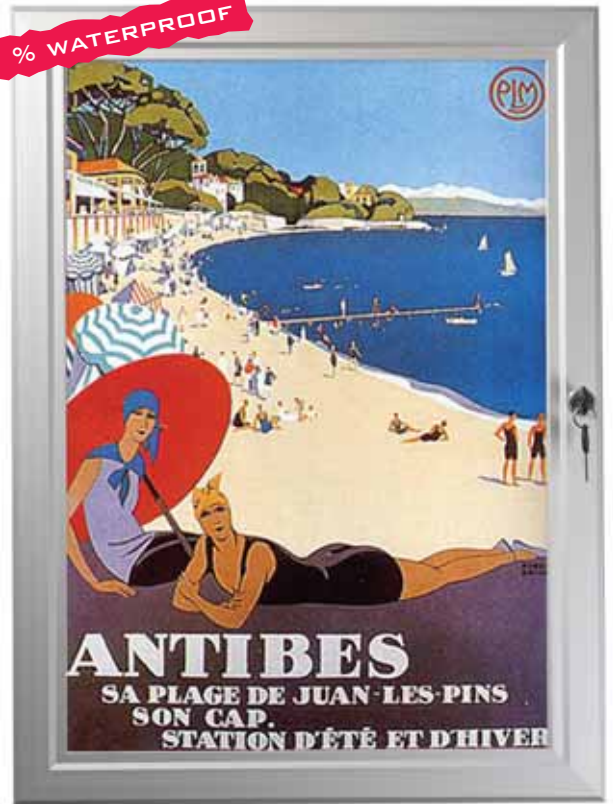

MATERIAL : Silver anodised aluminium					WEIGHT	PACKING SIZE
ARTICLE	EXTERNAL (x-y)	POSTER	COPY	KEY	WITH PACKING	*W X H X D
USBN0000A3	367 X 490 mm	297 X 420 mm	277 X 400 mm	1	2,600 kg	380 X 510 X 63 mm
USBN0000A2	490 X 664 mm	420 X 594 mm	400 X 574 mm	1	3,840 kg	510 X 680 X 63 mm
USBN0000A1	664 X 911 mm	594 X 841 mm	574 X 821 mm	2	5,700 kg	680 X 930 X 63 mm
USBN0000A0	911 X 1259 mm	841 X 1189 mm	821 X 1169 mm	2	10,000 kg	930 X 1280 X 63 mm
USBN0000B2	570 X 770 mm	500 X 700 mm	480 X 680 mm	1	4,740 kg	590 X 790 X 63 mm
USBN0000B1	770 X 1070 mm	700 X 1000 mm	680 X 980 mm	2	8,000 kg	790 X 1090 X 63 mm
USBN000023	578 X 832 mm	508 X 762 mm	488 X 742 mm	1	5,160 kg	600 X 850 X 63 mm
USBN000034	832 X 1086 mm	762 X 1016 mm	742 X 996 mm	2	8,710 kg	850 X 1100 X 63 mm



* W:Width H: Height D: Depth

Suitable for out door use. It has a cork backing and each unit includes a free set of pins. Single key 4x4, double key 6x4, 9x4 and 12x4 sizes are available and can be used both in portrait & landscape positions. The cover can be opened 90 degrees. Each unit includes mounting screw and dobels for easy wall mounting and a free set of pins. The profile width is 45 mm and the depth of the case 30 mm.



100% WATERPROOF



Each product includes 1 key set of single variation.

2 handles at each end help to keep the cover door open.

Please throw away the protection film on the unit before use.
Please throw away the silicagel on the cork before use.

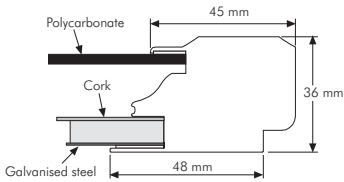
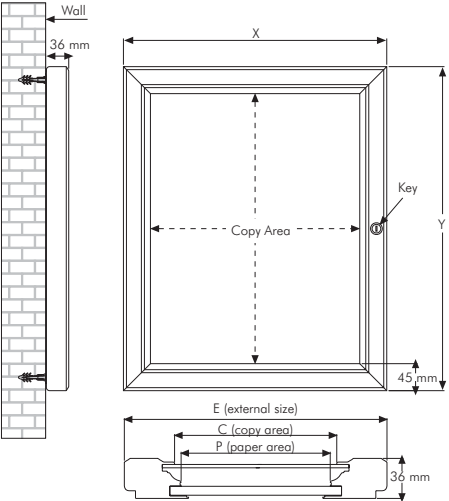

MATERIAL : Silver anodised aluminium						WEIGHT	PACKING SIZE
ARTICLE	EXTERNAL (x-y)	COPY	PAPER AREA	CAPACITY	KEY	WITH PACKING	*W X H X D
USBN1004A4	585 X 755 mm	495 X 665 mm	483 X 653 mm	4 X A4	1	6,870 kg	620 X 780 X 63 mm
USBN1006A4	585 X 1075 mm	495 X 985 mm	483 X 973 mm	6 X A4	2	8,950 kg	620 X 1100 X 63 mm
USBN1009A4	815 X 1075 mm	725 X 985 mm	713 X 973 mm	9 X A4	2	12,500 kg	850 X 1100 X 63 mm
USBN1012A4	1045 X 1075 mm	955 X 985 mm	943 X 973 mm	12 X A4	2	15,400 kg	1080 X 1100 X 63 mm



* W:Width H: Height D: Depth

Magnetic Showboard

Suitable for out door use. It has a dry-wipe magnetic surface, suitable for writing with boardmarker. Single key 4xA4, double key 6xA4, 9xA4 and 12xA4 sizes are available and can be used both in portrait & landscape positions. The cover can be opened 90 degrees. Each unit includes mounting screw and dobel and magnet buttons to fix the poster. The profile width is 45 mm and the depth of the case 30 mm.



 Each product includes 1 key set of single variation.

 Each unit comes with a free set of magnets. 2 handles at each end help to keep the cover door open.

 Please throw away the protection film on the unit before use.

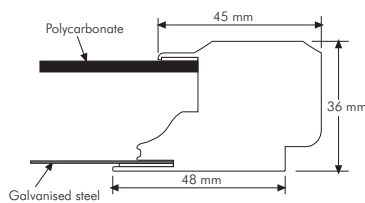
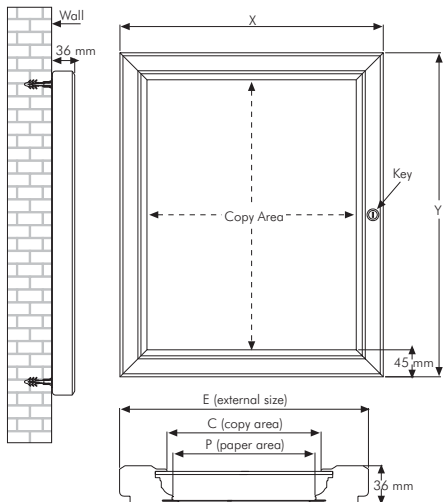

MATERIAL : Silver anodised aluminium						WEIGHT	PACKING SIZE
ARTICLE	EXTERNAL (x-y)	COPY	PAPER AREA	CAPACITY	KEY	WITH PACKING	*W X H X D
USBN2004A4	585 X 755 mm	495 X 665 mm	483 X 653 mm	4 X A4	1	6,000 kg	620 X 780 X 63 mm
USBN2006A4	585 X 1075 mm	495 X 985 mm	483 X 973 mm	6 X A4	2	8,350 kg	620 X 1100 X 63 mm
USBN2009A4	815 X 1075 mm	725 X 985 mm	713 X 973 mm	9 X A4	2	11,600 kg	850 X 1100 X 63 mm
USBN2012A4	1045 X 1075 mm	955 X 985 mm	943 X 973 mm	12 X A4	2	14,210 kg	1080 X 1100 X 63 mm



*W:Width H: Height D: Depth

Suitable for out door use. M&C Showboard has a cork backing & a perforated steel backing that allows the use of both magnet buttons & pins for cork together. Single key 4xA4, double key 6xA4, 9xA4 and 12xA4 sizes are available and can be used both in portrait & landscape positions. The cover can be opened 90 degrees. Each unit includes mounting screw and dodels. The profile width is 45 mm and the depth of the case 30 mm.



Each product includes 1 key set of single variation.

Each unit comes with a free set of pins & magnets. 2 handles at each end help to keep the cover door open.

Please throw away the protection film on the unit before use.

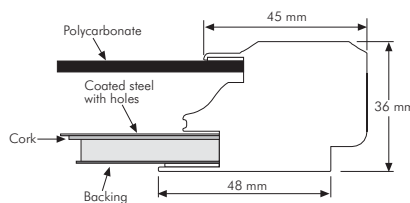
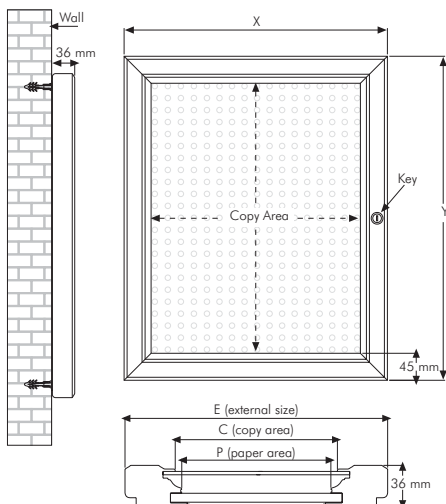

MATERIAL : Silver anodised aluminium						WEIGHT	PACKING SIZE
ARTICLE	EXTERNAL (x-y)	COPY	PAPER AREA	CAPACITY	KEY	WITH PACKING	*W X H X D
USBN3004A4	585 X 755 mm	495 X 665 mm	483 X 653 mm	4 X A4	1	8,250 kg	620 X 780 X 63 mm
USBN3006A4	585 X 1075 mm	495 X 985 mm	483 X 973 mm	6 X A4	2	11,000 kg	620 X 1100 X 63 mm
USBN3009A4	815 X 1075 mm	725 X 985 mm	713 X 973 mm	9 X A4	2	15,100 kg	850 X 1100 X 63 mm
USBN3012A4	1045 X 1075 mm	955 X 985 mm	943 X 973 mm	12 X A4	2	19,000 kg	1080 X 1100 X 63 mm



*W:Width H: Height D: Depth

Felt Showboard

Suitable for out door use. It has a felt backing that welcomes both velcro and pins. Each unit includes a free set of pins. Single key 4x A4, double key 6x A4, 9x A4 and 12x A4 sizes are available and can be used both in portrait & landscape positions. The cover can be opened 90 degrees. Each unit includes mounting screw and dobels for easy wall mounting and a free set of pins. The profile width is 45 mm and the depth of the case 30 mm.



VELCRO FRIENDLY

NEW



Each product includes 1 key set of single variation.

2 handles at each end help to keep the cover door open.

Please throw away the protection film on the unit before use.
Please throw away the silicagel on the felt before use.

Choice of 4 felt colours:

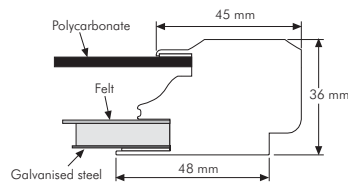
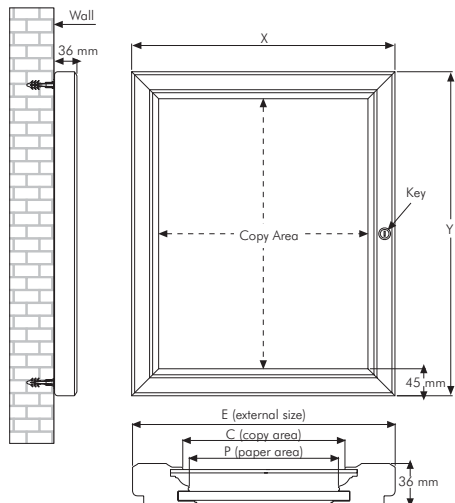
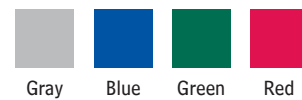

MATERIAL : Silver anodised aluminium							WEIGHT	PACKING SIZE
RED	GREEN	EXTERNAL (x-y)	COPY	PAPER AREA	CAPACITY	KEY	WITH PACKING	*W X H X D
USBN1104A4	USBN1304A4	585 X 755 mm	495 X 665 mm	483 X 653 mm	4 X A4	1	8,450 kg	620 X 780 X 63 mm
USBN1106A4	USBN1306A4	585 X 1075 mm	495 X 985 mm	483 X 973 mm	6 X A4	2	10,400 kg	620 X 1100 X 63 mm
USBN1109A4	USBN1309A4	815 X 1075 mm	725 X 985 mm	713 X 973 mm	9 X A4	2	14,100 kg	850 X 1100 X 63 mm
USBN1112A4	USBN1312A4	1045 X 1075 mm	955 X 985 mm	943 X 973 mm	12 X A4	2	18,000 kg	1080 X 1100 X 63 mm



*W:Width H: Height D: Depth

Suitable for out door use. It has a felt backing that welcomes both velcro and pins. Each unit includes a free set of pins. Single key 4x4, double key 6x4, 9x4 and 12x4 sizes are available and can be used both in portrait & landscape positions. The cover can be opened 90 degrees. Each unit includes mounting screw and dobels for easy wall mounting and a free set of pins. The profile width is 45 mm and the depth of the case 30 mm.

VELCRO FRIENDLY

NEW



Each product includes 1 key set of single variation.

2 handles at each end help to keep the cover door open.

Please throw away the protection film on the unit before use.
Please throw away the silicagel on the felt before use.



Choice of 4 felt colours:

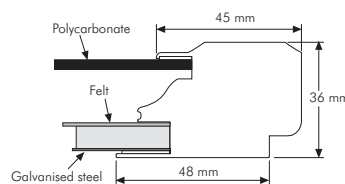
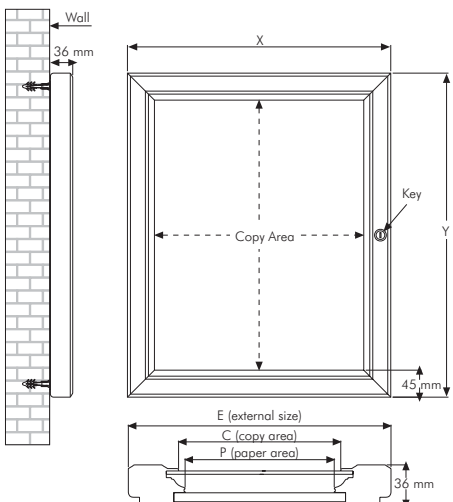
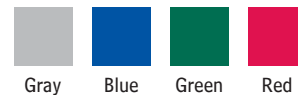

MATERIAL : Silver anodised aluminium							WEIGHT	PACKING SIZE
BLUE	GRAY	EXTERNAL (x-y)	COPY	PAPER AREA	CAPACITY	KEY	WITH PACKING	*W X H X D
USBN1204A4	USBN1404A4	585 X 755 mm	495 X 665 mm	483 X 653 mm	4 X A4	1	8,450 kg	620 X 780 X 63 mm
USBN1206A4	USBN1406A4	585 X 1075 mm	495 X 985 mm	483 X 973 mm	6 X A4	2	10,400 kg	620 X 1100 X 63 mm
USBN1209A4	USBN1409A4	815 X 1075 mm	725 X 985 mm	713 X 973 mm	9 X A4	2	14,100 kg	850 X 1100 X 63 mm
USBN1212A4	USBN1412A4	1045 X 1075 mm	955 X 985 mm	943 X 973 mm	12 X A4	2	18,000 kg	1080 X 1100 X 63 mm



*W:Width H: Height D: Depth

Suitable for indoor use. It has 2 different backing models. Each unit includes a free set of pins or magnets. Single key 4xA4, double key 6xA4, 9xA4 and 12xA4 sizes are available and can be used both in portrait & landscape positions. The cover can be opened 90 degrees. Each unit includes mounting screw and dobels for easy wall mounting. The depth of the case is 35 mm.



Each product includes 1 key set of single variation.

! Please throw away the protection film on the unit before use.
Please throw away the silicagel on the cork before use.

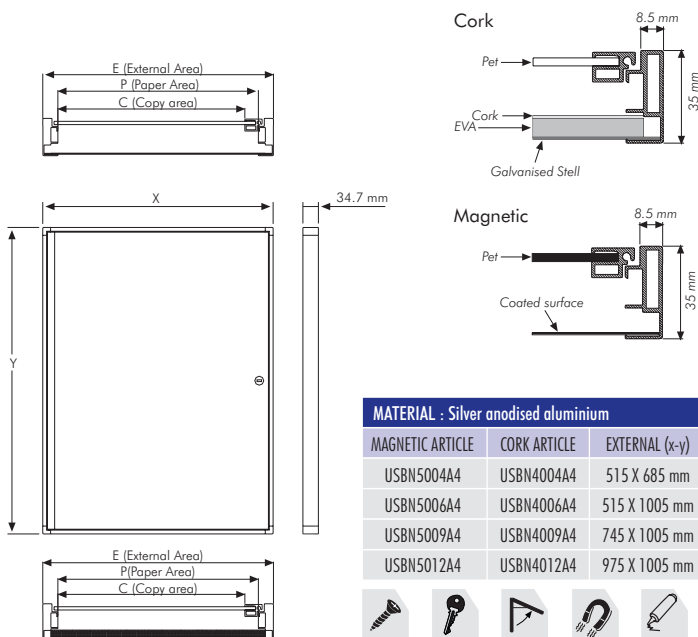

MATERIAL : Silver anodised aluminium						WEIGHT WITH PACKING		PACKING SIZE	
MAGNETIC ARTICLE	CORK ARTICLE	EXTERNAL (x-y)	COPY	PAPER AREA	CAPACITY	KEY	MAGNETIC	CORK	*W X H X D
USBN5004A4	USBN4004A4	515 X 685 mm	474 X 657 mm	487 X 657 mm	4 X A4	1	4,390 kg	4,650 kg	545 X 715 X 63 mm
USBN5006A4	USBN4006A4	515 X 1005 mm	474 X 977 mm	487 X 977 mm	6 X A4	2	6,495 kg	6,880 kg	545 X 1035 X 63 mm
USBN5009A4	USBN4009A4	745 X 1005 mm	704 X 977 mm	717 X 977 mm	9 X A4	2	8,670 kg	9,230 kg	745 X 1035 X 63 mm
USBN5012A4	USBN4012A4	975 X 1005 mm	934 X 977 mm	947 X 977 mm	12 X A4	2	10,920 kg	11,660 kg	1005 X 1035 X 63 mm





*W:Width H: Height D: Depth

Height is 1920 mm. Many different sizes are available. Single key 4xA4, double key 6xA4, 9xA4 and 12xA4 sizes are available and can be used both in portrait & landscape positions in Showboards. The cover can be opened 90 degrees. Clear acrylic shelves and steel shelves can be added if desired.



 Each product includes connectors at the back & 1 key set of single variation.

 Handles at both end help to keep the cover door open.

 Please throw away the protection film on the cover before use.



Poster Showboard



Showboard with Cork

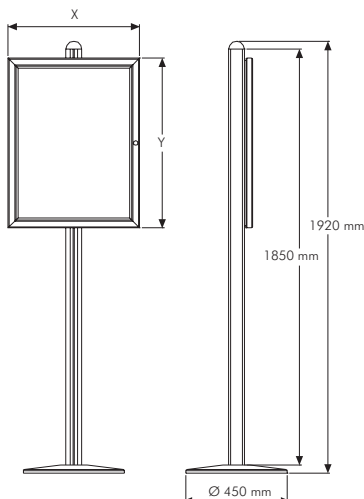

MAIN BODY :
Silver anodised aluminium

ARTICLE
UFSLO01000



SHOWBOARD WITH CORK			WEIGHT	PACKING SIZE
ARTICLE	EXTERNAL (x-y)	CAPACITY	WITH PACKING	*W X H X D
UFSLO30000	585 X 755 mm	4 X A4	6,600 kg	620 X 780 X 63 mm
UFSLO31000	585 X 1075 mm	6 X A4	8,900 kg	620 X 1100 X 63 mm

POSTER SHOWBOARD			WEIGHT	PACKING SIZE
ARTICLE	EXTERNAL (x-y)	POSTER SIZE	WITH PACKING	*W X H X D
UFSLO21000	490 X 664 mm	420 X 594 mm	3,750 kg	510 X 680 X 63 mm
UFSLO20000	664 X 911 mm	594 X 841 mm	5,700 kg	680 X 930 X 63 mm
UFSLO23000	570 X 770 mm	500 X 700 mm	4,870 kg	590 X 790 X 63 mm
UFSLO24000	770 X 1070 mm	700 X 1000 mm	7,900 kg	790 X 1090 X 63 mm
UFSLO25000	578 X 832 mm	508 X 762 mm	5,100 kg	600 X 850 X 63 mm





*W:Width H: Height D: Depth

Single Leg Showboards

Height is 1920 mm. Many different sizes are available. Single key 4xA4, double key 6xA4, 9xA4 and 12xA4 sizes are available and can be used both in portrait & landscape positions in Showboards. The cover can be opened 90 degrees. Clear acrylic shelves and steel shelves can be added if desired.



-  Each product includes connectors at the back & 1 key set of single variation.
-  Handles at each end help to keep the cover door open.
-  Please throw away the protection film on the unit before use.



Magnetic Showboard



M&C Showboard

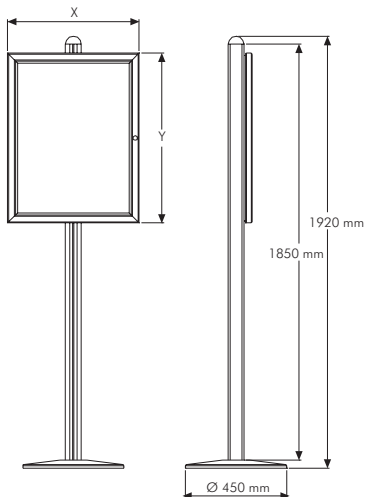

M&C SHOWBOARD			WEIGHT	PACKING SIZE
ARTICLE	EXTERNAL (x-y)	CAPACITY	WITH PACKING	*W X H X D
UFSLO40000	585 X 755 mm	4 X A4	7,950 kg	620 X 780 X 63 mm
UFSLO41000	585 X 1075 mm	6 X A4	11,000 kg	620 X 1100 X 63 mm
MAGNETIC SHOWBOARD			WEIGHT	PACKING SIZE
ARTICLE	EXTERNAL (x-y)	CAPACITY	WITH PACKING	*W X H X D
UFSLO35000	585 X 755 mm	4 X A4	6,000 kg	620 X 780 X 63 mm
UFSLO36000	585 X 1075 mm	6 X A4	8,200 kg	620 X 1100 X 63 mm

MAIN BODY : Silver anodised aluminium	
ARTICLE	
UFSLO01000	





*W:Width H: Height D: Depth

Height is 1760 mm. Single or double faced alternatives. Many different sizes are available. The cover can be opened 90 degrees. Single or double sided shelves can be added and 4 wheels can be added if desired.



 Each unit is packed with unassembled legs, including the fixing set & 1 key set of single variation.

 Handles at each end help to keep the cover door open.

 Please throw away the protection film on the unit before use.

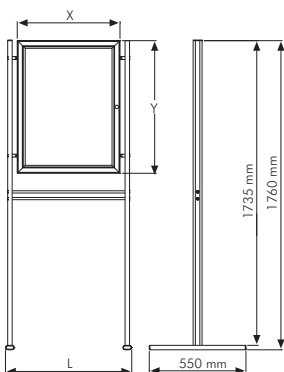
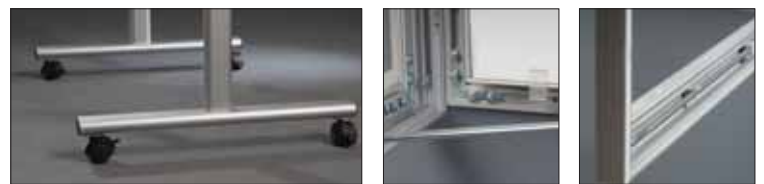

SHOWBOARD WITH CORK					WEIGHT WITH PACKING		PACKING SIZE / *W X H X D	
SINGLE SIDED	DOUBLE SIDED	EXTERNAL (x-y)	L	CAPACITY	SINGLE SIDED	DOUBLE SIDED	SINGLE SIDED	DOUBLE SIDED
UIB715N4A4	UIB745N4A4	585 X 755 mm	710 mm	4 X A4	13,300 kg	19,300 kg	700 X 1780 X 75 mm	700 X 1780 X 95 mm
UIB715N6A4	UIB745N6A4	585 X 1075 mm	710 mm	6 X A4	14,800 kg	20,300 kg	700 X 1780 X 75 mm	700 X 1780 X 95 mm
UIB715N9A4	UIB745N9A4	815 X 1075 mm	940 mm	9 X A4	21,300 kg	33,000 kg	940 X 1780 X 75 mm	940 X 1780 X 95 mm

POSTER SHOWBOARD						WEIGHT WITH PACKING		PACKING SIZE / *W X H X D	
SINGLE SIDED	DOUBLE SIDED	EXTERNAL (x-y)	L	POSTER	COPY	SINGLE SIDED	DOUBLE SIDED	SINGLE SIDED	DOUBLE SIDED
UIB705TNA2	UIB705CNA2	490 X 664 mm	615 mm	420 X 594 mm	400 X 574 mm	9,700 kg	12,600 kg	630 X 1780 X 75 mm	630 X 1780 X 95 mm
UIB705TNA1	UIB705CNA1	664 X 911 mm	790 mm	594 X 841 mm	574 X 821 mm	10,620 kg	14,620 kg	800 X 1780 X 75 mm	800 X 1780 X 95 mm
UIB705TNB2	UIB705CNB2	570 X 770 mm	695 mm	500 X 700 mm	480 X 680 mm	10,120 kg	13,620 kg	710 X 1780 X 75 mm	710 X 1780 X 95 mm
UIB705TNB1	UIB705CNB1	770 X 1070 mm	895 mm	700 X 1000 mm	680 X 980 mm	13,000 kg	20,000 kg	910 X 1780 X 75 mm	910 X 1780 X 95 mm
UIB705TN23	UIB705CN23	578 X 832 mm	703 mm	508 X 762 mm	588 X 742 mm	10,300 kg	13,950 kg	720 X 1780 X 75 mm	720 X 1780 X 95 mm
UIB705TN34	UIB705CN34	832 X 1086 mm	957 mm	762 X 1016 mm	742 X 996 mm	13,620 kg	20,620 kg	970 X 1780 X 75 mm	970 X 1780 X 95 mm





*W:Width H: Height D: Depth

Double Leg Showboards

Height is 1760 mm. Single or double faced alternatives. Many different sizes are available. The cover can be opened 90 degrees. Single or double sided shelves can be added and 4 wheels can be added if desired.



 Each unit is packed with unassembled legs, including the fixing set & 1 key set of single variation.

 Handles at each end help to keep the cover door open.

 Please throw away the protection film on the unit before use. Shelves & wheels are optional, are not included in the original pack.

Magnetic Showboard

M&C Showboard

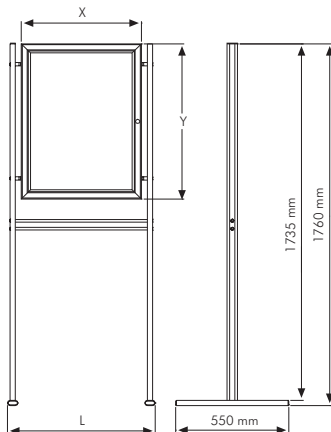

M&C SHOWBOARD					WEIGHT WITH PACKING		PACKING SIZE *W X H X D	
SINGLE SIDED	DOUBLE SIDED	EXTERNAL (x-y)	L	CAPACITY	SINGLE SIDED	DOUBLE SIDED	SINGLE SIDED	DOUBLE SIDED
UIB735N4A4	UIB765N4A4	585 X 755 mm	710 mm	4 X A4	15,000 kg	20,150 kg	700 X 1780 X 75 mm	700 X 1780 X 95 mm
UIB735N6A4	UIB765N6A4	585 X 1075 mm	710 mm	6 X A4	16,500 kg	25,500 kg	700 X 1780 X 75 mm	700 X 1780 X 95 mm
UIB735N9A4	UIB765N9A4	815 X 1075 mm	940 mm	9 X A4	25,300 kg	37,500 kg	940 X 1780 X 75 mm	940 X 1780 X 95 mm

MAGNETIC SHOWBOARD					WEIGHT WITH PACKING		PACKING SIZE *W X H X D	
SINGLE SIDED	DOUBLE SIDED	EXTERNAL (x-y)	L	CAPACITY	SINGLE SIDED	DOUBLE SIDED	SINGLE SIDED	DOUBLE SIDED
UIB725N4A4	UIB755N4A4	585 X 755 mm	710 mm	4 X A4	15,100 kg	20,150 kg	700 X 1780 X 75 mm	700 X 1780 X 95 mm
UIB725N6A4	UIB755N6A4	585 X 1075 mm	710 mm	6 X A4	16,500 kg	25,500 kg	700 X 1780 X 75 mm	700 X 1780 X 95 mm
UIB725N9A4	UIB755N9A4	815 X 1075 mm	940 mm	9 X A4	25,300 kg	37,500 kg	940 X 1780 X 75 mm	940 X 1780 X 95 mm

*W:Width H: Height D: Depth

