

# Illuminated Products





- Lightbox
- Convex Lightbox
- Snap Light
- Totem
- Decorative Totem
- Tailor made design



Double or single faced lightbox are in various size. The snap frames enable you to change the display material easily whenever desired. The surface is opaque acrylic. Anti-reflex PET cover and 25 mm profile snap frames. Mitred corner. Illuminated box for duratrans and posters.



 Comes along with 2m electrical cable & plug. UK plug must be mentioned on order.

 Please take the acrylic out when required to change a lamp. All units pass CE/UL Pat test & comes along with their certificates. No hanging accessories are included in the original pack.

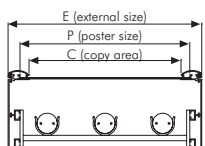
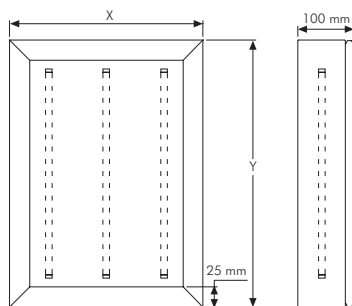
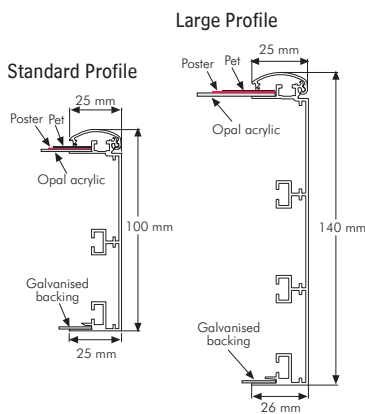

MATERIAL : Silver anodised aluminium & large profile						WEIGHT WITH PACKING		PACKING SIZE
SINGLE SIDED	DOUBLE SIDED	EXTERNAL (x-y)	POSTER	COPY	LIGHTING	SINGLE SIDED	DOUBLE SIDED	*W X H X D
ULBT140NA1	ULBC140NA1	624 X 871 mm	594 X 841 mm	572 X 819 mm	5 X 15 W	12,300 kg	12,300 kg	650 X 930 X 160 mm
ULBT140NA0	ULBC140NA0	871 X 1219 mm	841 X 1189 mm	819 X 1167 mm	4 X 30 W	21,100 kg	21,100 kg	900 X 1300 X 160 mm
ULBT140NB1	ULBC140NB1	730 X 1030 mm	700 X 1000 mm	678 X 978 mm	3 X 30 W	15,400 kg	15,400 kg	750 X 1100 X 160 mm
ULBT140NB0	ULBC140NB0	1030 X 1430 mm	1000 X 1400 mm	978 X 1378 mm	5 X 36 W	25,300 kg	25,300 kg	1050 X 1500 X 160 mm
ULBT140N34	ULBC140N34	792 X 1046 mm	762 X 1016 mm	740 X 994 mm	4 X 30 W	16,420 kg	16,420 kg	810 X 1120 X 160 mm
ULBT140N46	ULBC140N46	1046 X 1554 mm	1016 X 1524 mm	994 X 1502 mm	5 X 58 W	26,000 kg	26,000 kg	1060 X 1630 X 160 mm

MATERIAL : Silver anodised aluminium & standard profile						WEIGHT WITH PACKING		PACKING SIZE
SINGLE SIDED	DOUBLE SIDED	EXTERNAL (x-y)	POSTER	COPY	LIGHTING	SINGLE SIDED	DOUBLE SIDED	*W X H X D
ULBT250NA3	ULBC250NA3	327 X 450 mm	297 X 420 mm	275 X 389 mm	1 X 32 W	3,200 kg	3,400 kg	350 X 490 X 125 mm
ULBT250NA2	ULBC250NA2	450 X 624 mm	420 X 594 mm	389 X 572 mm	2 X 15 W	6,310 kg	7,200 kg	460 X 690 X 125 mm
ULBT250NA1	ULBC250NA1	624 X 871 mm	594 X 841 mm	572 X 819 mm	5 X 15 W	11,750 kg	12,750 kg	650 X 930 X 125 mm
ULBT250NA0	ULBC250NA0	871 X 1219 mm	841 X 1189 mm	819 X 1167 mm	4 X 30 W	17,700 kg	21,000 kg	900 X 1300 X 125 mm
ULBT250NB2	ULBC250NB2	530 X 730 mm	500 X 700 mm	478 X 678 mm	2 X 18 W	8,100 kg	8,100 kg	550 X 800 X 125 mm
ULBT250NB1	ULBC250NB1	730 X 1030 mm	700 X 1000 mm	678 X 978 mm	3 X 30 W	13,410 kg	16,000 kg	750 X 1100 X 125 mm
ULBT250NB0	ULBC250NB0	1030 X 1430 mm	1000 X 1400 mm	978 X 1378 mm	5 X 36 W	24,000 kg	26,000 kg	1050 X 1500 X 125 mm
ULBT250N23	ULBC250N23	538 X 792 mm	508 X 762 mm	486 X 740 mm	2 X 18 W	8,500 kg	8,900 kg	550 X 850 X 125 mm
ULBT250N34	ULBC250N34	792 X 1046 mm	762 X 1016 mm	740 X 994 mm	4 X 30 W	15,000 kg	16,900 kg	810 X 1120 X 125 mm
ULBT250N46	ULBC250N46	1046 X 1554 mm	1016 X 1524 mm	994 X 1502 mm	5 X 58 W	25,000 kg	27,000 kg	1060 X 1630 X 125 mm



\* W:Width H: Height D: Depth

Single faced convex boxes are in various sizes. The snap frames enable you to change the display material easily from two long sided whenever desired. The surface is opaque acrylic. Snap frame with 25 mm. profile. Convex Lightbox includes PET cover wich is ideal to illuminate for your duratrans & posters without shinning.



 Comes along with 2 m electrical cable & plug. UK plug must be mentioned on order.

 All units pass CE/UL Pat test & comes along with their certificates.

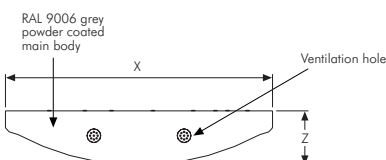
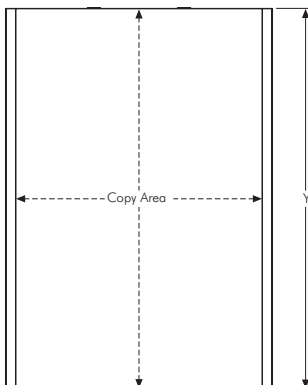
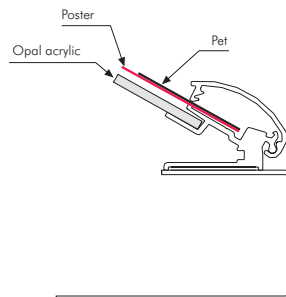

MATERIAL : Main body is RAL 9006 Powder Coated					WEIGHT	PACKING SIZE
ARTICLE	EXTERNAL (x-y-z)	POSTER	COPY	LIGHTING	WITH PACKING	*W X H X D
UCLB250NA3	308 X 423 X 82 mm	297 X 420 mm	273 X 420 mm	1 X 8 W	3,100 kg	335 X 445 X 95 mm
UCLB250NA2	424 X 597 X 98 mm	420 X 594 mm	395 X 594 mm	1 X 15 W	5,800 kg	450 X 625 X 110 mm
UCLB250NA1	592 X 844 X 120 mm	594 X 841 mm	570 X 841 mm	2 X 18 W	11,000 kg	625 X 875 X 130 mm
UCLB250NA0	828 X 1192 X 150 mm	841 X 1189 mm	816 X 1189 mm	2 X 30 W	18,300 kg	865 X 1225 X 160 mm
UCLB250NB2	500 X 703 X 110 mm	500 X 700 mm	475 X 700 mm	1 X 18 W	7,750 kg	530 X 725 X 120 mm
UCLB250NB1	692 X 1003 X 134 mm	700 X 1000 mm	675 X 1000 mm	2 X 30 W	13,730 kg	720 X 1025 X 145 mm
UCLB250N23	510 X 765 X 108 mm	508 X 762 mm	484 X 762 mm	1 X 18 W	7,980 kg	540 X 780 X 120 mm
UCLB250N34	750 X 1019 X 143 mm	762 X 1016 mm	737 X 1016 mm	2 X 30 W	14,810 kg	780 X 1040 X 150 mm

\* W:Width H: Height D: Depth



Thin snap frame that lights up your poster. Single and double sided options are available. The special acrylic in the middle provides a homogenous lighting for your posters. Ceiling hanging accessories are included in the original pack of double sided snaplight, and 2 metal wall hangers are included in the original pack of single sided Snaplight.

**High & Even Brightness:  
2,500~3,800Lux illumination.**



## IMPROVED LIGHT



- Easy to change graphics with front access. (Snap frame)
- Slim front cover of just 52 mm & 40-45mm deep.
- High & Even Brightness: 2,500~3,800Lux illumination.
- All-aluminium structure, silver anodized. (Other color available)
- 2M power cord and built in on/off switch.
- Bigger sizes like DIN B0 ,40"X60" sizes available.



Comes along with 2 m electrical cable & plug. UK plug must be mentioned on order.

All units pass CE/UL Pat test & comes along with their certificates.

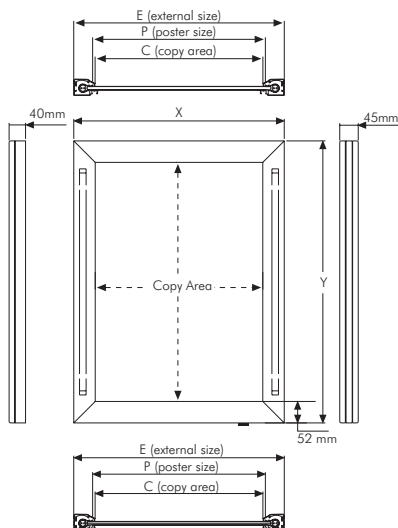
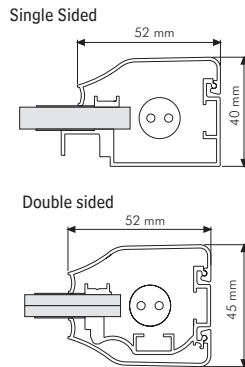

MATERIAL : Silver anodised aluminium						WEIGHT WITH PACKING		PACKING SIZE
SINGLE SIDED	DOUBLE SIDED	EXTERNAL (x-y)	POSTER	COPY	LIGHTING	SINGLE SIDED	DOUBLE SIDED	*W X H X D
USLT918NA3	USLC918NA3	384 X 507 mm	297 X 420 mm	280 X 403 mm	2 X 10 W	3,500 kg	5,110 kg	415 X 580 X 60 mm
USLT918NA2	USLC918NA2	507 X 681 mm	420 X 594 mm	403 X 577 mm	2 X 14 W	7,000 kg	8,240 kg	520 X 750 X 60 mm
USLT918NA1	USLC918NA1	681 X 928 mm	594 X 841 mm	577 X 824 mm	2 X 39 W	11,400 kg	13,450 kg	720 X 1010 X 60 mm
USLT918NA0	USLC918NA0	928 X 1276 mm	841 X 1189 mm	824 X 1172 mm	2 X 54 W	19,200 kg	21,300 kg	965 X 1380 X 60 mm
USLT918NB2	USLC918NB2	587 X 787 mm	500 X 700 mm	483 X 683 mm	2 X 14 W	9,250 kg	9,250 kg	615 X 870 X 60 mm
USLT918NB1	USLC918NB1	787 X 1087 mm	700 X 1000 mm	783 X 983 mm	2 X 39 W	15,800 kg	17,685 kg	815 X 1170 X 60 mm
USLT918NB0	USLC918NB0	1087 X 1487 mm	1000 X 1400 mm	983 X 1383 mm	2 X 80 W	23,500 kg	26,320 kg	1120 X 1570 X 60 mm
USLT918N23	USLC918N23	595 X 849 mm	508 X 762 mm	491 X 745 mm	2 X 14 W	9,800 kg	10,000 kg	630 X 930 X 60 mm
USLT918N34	USLC918N34	849 X 1103 mm	762 X 1016 mm	745 X 999 mm	2 X 39 W	15,700 kg	17,600 kg	910 X 1180 X 60 mm
USLT918N46	USLC918N46	1103 X 1611 mm	1016 X 1524 mm	999 X 1507 mm	2 X 80 W	27,000 kg	27,000 kg	1170 X 1700 X 60 mm

\* W:Width H: Height D: Depth



The snap frames enable you to change the display material easily whenever desired. Can be used as double sided. One can simply open the front profile to change the poster. Hinged door, magnetic cover close & plastic pegs on both sides add value to the unit.



! Each unit has a ventilation hole.



Patent Pending  
TR 2005 04637  
PCT/TR 2006/000016

RAL 9006 grey powdercoated

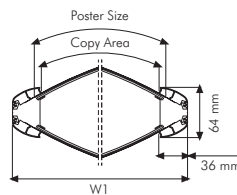
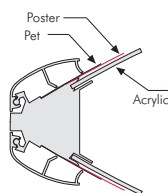
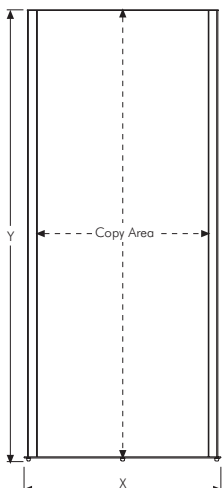
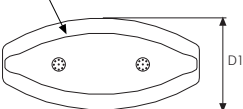

MATERIAL : Silver anodised aluminium							WEIGHT	PACKING SIZE
ARTICLE	EXTERNAL (x-y)	POSTER	COPY	D1	W1	LIGHTING	WITH PACKING	*W X H X D
UTTMO01000	650 X 1720 mm	600 X 1700 mm	580 X 1700 mm	350 mm	628 mm	1 X 58 W	28,000 kg	670 X 1750 X 85 mm
UTTMO02000	750 X 1720 mm	700 X 1700 mm	680 X 1700 mm	350 mm	723 mm	1 X 58 W	30,800 kg	770 X 1750 X 85 mm
UTTMO03000	850 X 1720 mm	800 X 1700 mm	780 X 1700 mm	370 mm	820 mm	2 X 58 W	36,500 kg	870 X 1750 X 85 mm



\* W:Width H: Height D: Depth



Each unit is packed unassembled with an easy instruction sheet. Comes a long with 2 m electrical cable & plug. UK plug must be mentioned on order.

! PVC hinge at one side & magnetic cover help the easy change of the poster. All units pass CE/UL Pat test & comes along with their certificates.



Patent Pending  
TR 2005 04637  
PCT/TR 2006/000016



Elegant look Decorative Totem that is designed with patterned polystyrene panel at the bottom. The snap frames enable you to change the display material easily whenever desired. Can be used as double sided. One can simply open the front profile to change the poster. Hinged door, magnetic cover close & plastic pegs on both sides add value to the unit.



Each unit is packed unassembled with an easy instruction sheet. Comes along with 2 m electrical cable & plug. UK plug must be mentioned on order.

! PVC hinge at one side & magnetic cover help the easy change of the poster. All units pass CE/UL Pat test & comes along with their certificates.

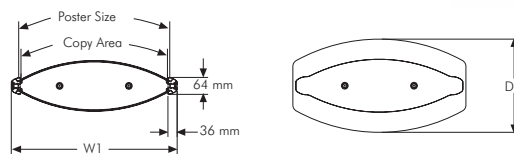
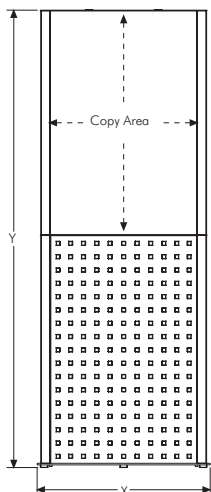

MATERIAL : Silver anodised aluminium							WEIGHT	PACKING SIZE
ARTICLE	EXTERNAL (x-y)	POSTER	COPY	D1	W1	LIGHTING	WITH PACKING	*W X H X D
UTTM011010	650 X 1720 mm	594 X 841 mm	574 X 841 mm	350 mm	623 mm	1 X 18 W	30,000 kg	670 X 1800 X 90 mm 380 X 680 X 40 mm
UTTM011030	880 X 1720 mm	841 X 1189 mm	821 X 1189 mm	370 mm	864 mm	2 X 36 W	35,200 kg	900X 1800 X 90 mm 380 X 900 X 40 mm
UTTM011040	560 X 1720 mm	500 X 700 mm	480 X 700 mm	350 mm	536 mm	1 X 18 W	25,750 kg	590 X 1800 X 90 mm 380 X 590 X 40 mm
UTTM011020	750 X 1720 mm	700 X 1000 mm	680 X 1189 mm	350 mm	727 mm	1 X 30 W	32,000 kg	790 X 1800 X 90 mm 380 X 790 X 40 mm



\* W:Width H: Height D: Depth

# Tailor made design

Elegant look Decorative Totem that is designed with extra literature dispensers at the bottom. The snap profiles enable you to change the display material easily whenever desired. One can simply open the front profile to change the poster. Hinged door, magnetic cover close & plastic pegs on all sides add value to the unit. Available in A1, A0, 500x700 mm, 700x1000 mm sizes. Can be customised according to your customer's needs.

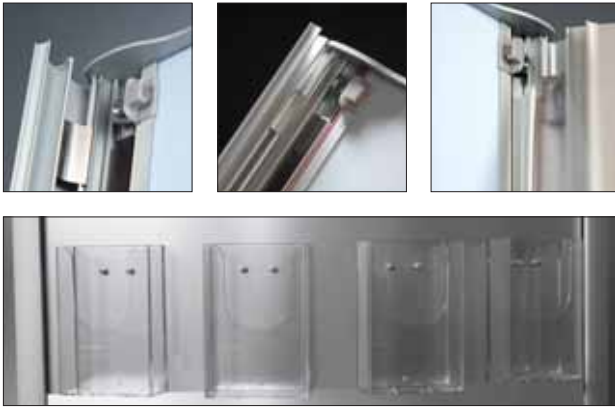

Each unit is packed unassembled with an easy instruction sheet. Comes along with 2 m electrical cable & plug. UK plug must be mentioned on order.

PVC hinge at one side & magnetic cover help the easy change of the poster. All units pass CE/UL Pat test & comes along with their certificates.

