

Poster Holders

Poster Holders



- Strech Frame
- Poster Snap
- Poster Clamp
- Newage Poster Clamp
- Poster Fast
- Fast Note

Strech Frame

Lightweight frame that stretches the poster within, from 4 corners. Poster can be simply changed via plastic clips. Available as standard in silver eloxiert. Other colours available on request. Includes two U hangers for both wallmounting and ceiling suspending. Plastic clips springed from corners hold the poster in center and do not spoil or ruin the poster paper.



Single packed unassembled in carton tubes with an easy mounting instruction sheet. Each pack includes 4 clips & 2 hanger.

Hangers are suitable for wall mounting & ceiling suspension.

Suggested poster material is paper, any heavier material such as vinyl or textile may damage the springs on the corner. Accessories such as suction caps & ceiling hangers are optional. Suitable for silk-screen printing max. letter height is 8 mm.

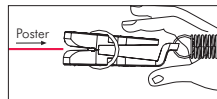
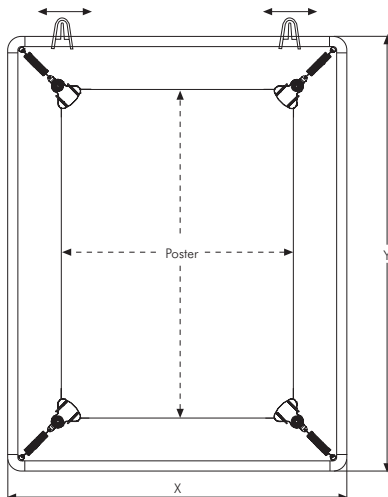
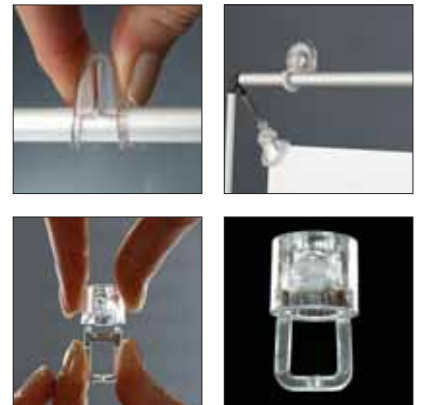

MATERIAL : Silver anodised aluminium			WEIGHT	PACKING SIZE (50 pcs)
ARTICLE	EXTERNAL (x-y)	POSTER	WITH PACKING	*W X H X D
UPSCN000A4	310 X 397 mm	210 X 297 mm	0,220kg	420 X 570 X 220 mm
UPSCN000A3	397 X 520 mm	297 X 420 mm	0,265 kg	420 X 700 X 220 mm
UPSCN000A2	520 X 694 mm	420 X 594 mm	0,340 kg	420 X 870 X 220 mm
UPSCN000A1	694 X 941 mm	594 X 841 mm	0,432 kg	420 X 1110 X 220 mm
UPSCN000B2	600 X 800 mm	500 X 700 mm	0,380 kg	420 X 970 X 220 mm
UPSCN000B1	800 X 1100 mm	700 X 1000 mm	0,510 kg	420 X 1260 X 220 mm





* W:Width H: Height D: Depth

One set includes the upper and the bottom profiles.



 In top snap 10 mm poster & in bottom snap 10 mm poster is placed within the clamping system. Single packed as a set in plastic bags.

 No tool assembly.

 Moving hangers help easy assembly. Suitable for silk-screen printing max. letter height is 10 mm.

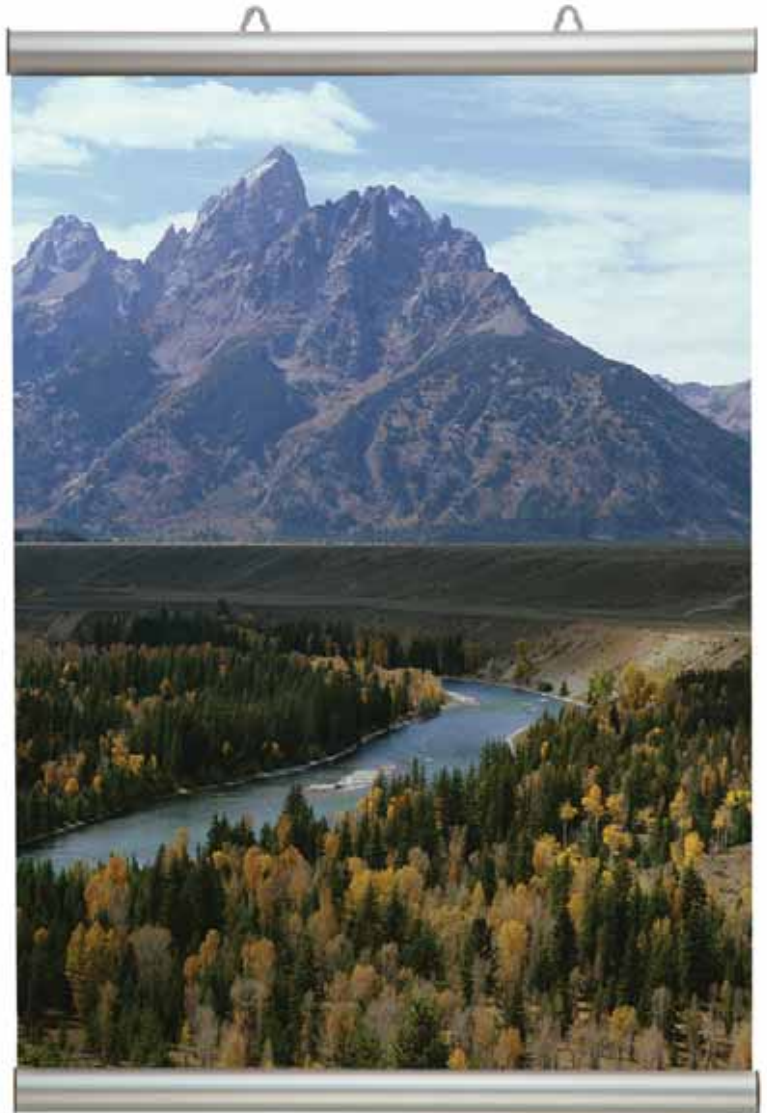

Patent Pending
TR 2005 01301

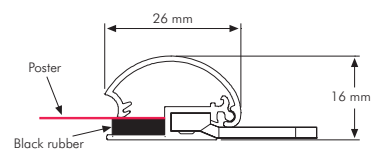
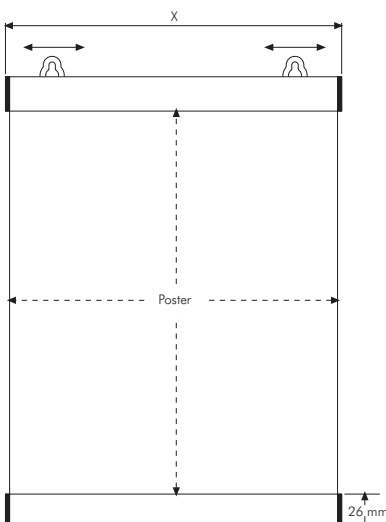

MATERIAL : Silver anodised aluminium			WEIGHT	PACKING SIZE
PROFILE : 26 mm				
ARTICLE	EXTERNAL (x)	POSTER	WITH PACKING	*W X H X D
UPT26SN021	216 mm	210 mm	5,700 kg	220 X 260 X 320 mm (50 pcs)
UPT26SN030	303 mm	297 mm	8,500 kg	220 X 360 X 320 mm (50 pcs)
UPT26SN042	426 mm	420 mm	11,500 kg	220 X 480 X 320 mm (50 pcs)
UPT26SN050	506 mm	500 mm	13,200 kg	220 X 560 X 320 mm (50 pcs)
UPT26SN060	600 mm	594 mm	17,000 kg	220 X 660 X 320 mm (50 pcs)
UPT26SN070	706 mm	700 mm	19,000 kg	220 X 760 X 320 mm (50 pcs)
UPT26SN085	847 mm	841 mm	12,000 kg	180 X 910 X 220 mm (25 pcs)
UPT26SN100	1006 mm	1000 mm	13,500 kg	180 X 1070 X 220 mm (25 pcs)

* W: Width H: Height D: Depth





Poster Clamp

Suitable for heavier and bigger posters in thickness 50 micron - 500 micron.



 In top clamp 15 mm poster & in bottom clamp 15 mm poster is placed within the clamping system. Single packed as set in plastic bags. Turning end caps help sliding the poster-in.

 No tool assembly. Hangers are suitable for wall mounting & ceiling suspension.

 Moving hangers help easy assembly. Once used a with thicker than 500 micron, posters the clamp may not hold thinner materials in the next use. Suitable for silk-screen printing max. letter height is 18 mm.

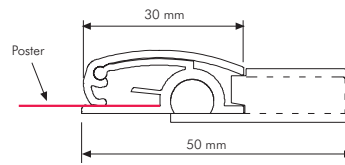
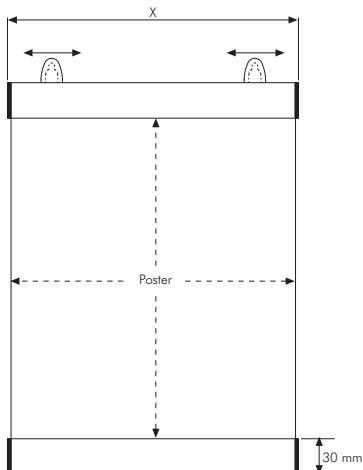

MATERIAL : Silver anodised aluminium			WEIGHT	PACKING SIZE
ARTICLE	EXTERNAL (x)	POSTER	WITH PACKING	*W X H X D
UPCOOSN021	216 mm	210 mm	9,570 kg	220 X 260 X 320 mm (50 pcs)
UPCOOSN030	303 mm	297 mm	12,000 kg	220 X 360 X 320 mm (50 pcs)
UPCOOSN042	426 mm	420 mm	18,500 kg	220 X 480 X 320 mm (50 pcs)
UPCOOSN050	506 mm	500 mm	22,200 kg	220 X 560 X 320 mm (50 pcs)
UPCOOSN060	600 mm	594 mm	26,600 kg	220 X 660 X 320 mm (50 pcs)
UPCOOSN070	706 mm	700 mm	31,000 kg	220 X 760 X 320 mm (50 pcs)
UPCOOSN085	847 mm	841 mm	19,000 kg	180 X 910 X 220 mm (25 pcs)
UPCOOSN100	1006 mm	1000 mm	22,000 kg	180 X 1070 X 220 mm (25 pcs)

* W:Width H: Height D: Depth



A new serie of poster holder just created that offers competitive deals. Suitable for posters in thickness 50 micron / 500 micron.



 In top clamp 10 mm poster and in bottom clamp 10 mm poster is placed within the clamping system. Single packed as set in plastic bags. Turning end caps help sliding the poster-in.

 No tool assembly. Hangers are suitable for wall mounting and ceiling suspension. Moving hangers help easy assembly.

 Product is not recommended to be used in special sizes wider then 1000 mm and longer then 2000 mm. Suitable for silk-screen printing max. letter height is 15 mm.

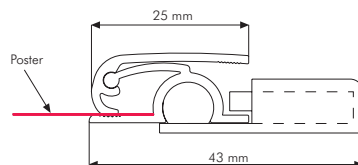
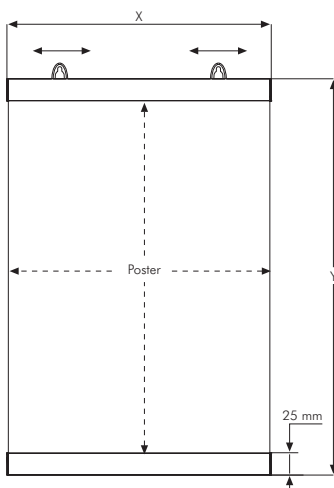
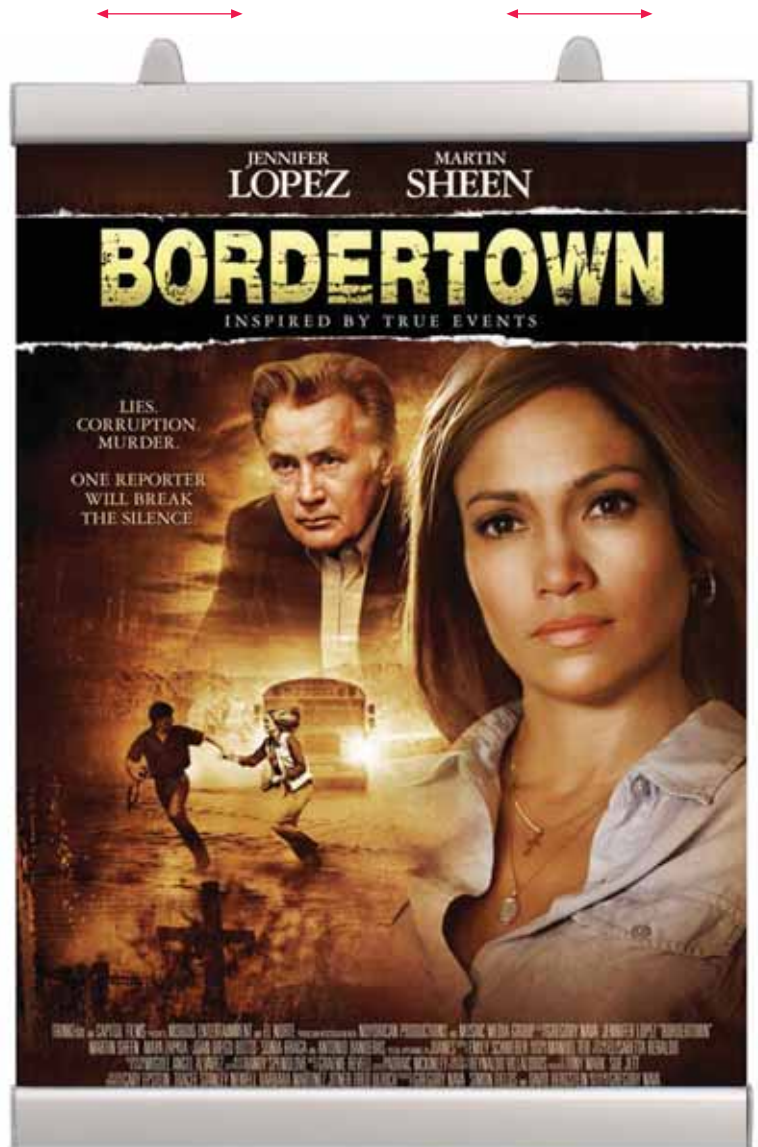



MATERIAL : Silver anodised aluminium			WEIGHT	PACKING SIZE
ARTICLE	EXTERNAL (x)	POSTER	WITH PACKING	*W X H X D
UPC1OSN021	213 mm	210 mm	7,300 kg	220 X 260 X 320 mm (50 pcs)
UPC1OSN030	303 mm	300 mm	10,550 kg	220 X 360 X 320 mm (50 pcs)
UPC1OSN042	423 mm	420 mm	13,800 kg	220 X 480 X 320 mm (50 pcs)
UPC1OSN050	503 mm	500 mm	16,800 kg	220 X 560 X 320 mm (50 pcs)
UPC1OSN060	603 mm	600 mm	20,300 kg	220 X 660 X 320 mm (50 pcs)
UPC1OSN070	703 mm	700 mm	22,800 kg	220 X 760 X 320 mm (50 pcs)
UPC1OSN085	853 mm	850 mm	13,800 kg	180 X 910 X 220 mm (25 pcs)
UPC1OSN100	1003 mm	1000 mm	17,250 kg	180 X 1070 X 220 mm (25 pcs)
UPC1OSN120	1203 mm	1200 mm	21,000 kg	180 X 1260 X 220 mm (25 pcs)

* W:Width H: Height D: Depth

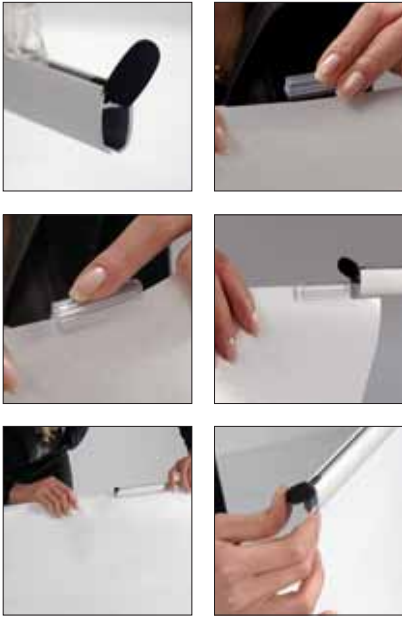

Suitable for heavier and bigger posters in thickness 10 micron - 500 micron. A double sided poster holder.



 In top snap 10 mm poster & in bottom snap 10 mm poster is placed within the clamping system. Single packed as a set in plastic bags.

 No tool assembly. Turning end caps help sliding the poster-in. Moving hangers help easy assembly. Hangers are suitable for wall mounting & ceiling suspension.

 Suitable for silk-screen printing max. letter height is 10 mm.

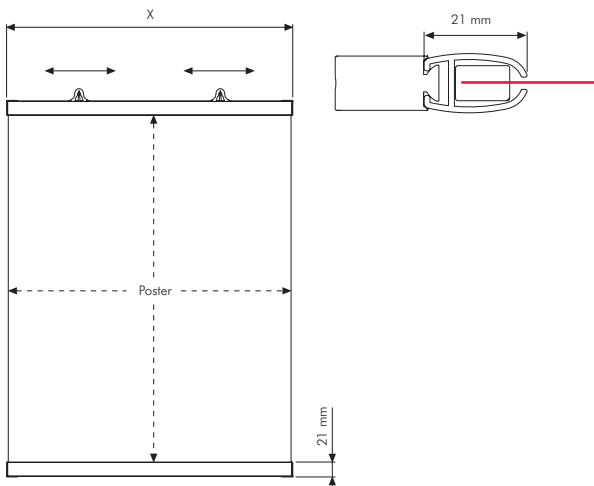



MATERIAL : Silver anodised aluminium			WEIGHT	PACKING SIZE
ARTICLE	EXTERNAL (x)	POSTER	WITH PACKING	*W X H X D
UPF21SN021	215 mm	210 mm	5,300 kg	220 X 260 X 320 mm (50 pcs)
UPF21SN030	302 mm	297 mm	6,900 kg	220 X 360 X 320 mm (50 pcs)
UPF21SN042	425 mm	420 mm	9,450 kg	220 X 480 X 320 mm (50 pcs)
UPF21SN050	505 mm	500 mm	11,000 kg	220 X 560 X 320 mm (50 pcs)
UPF21SN060	599 mm	594 mm	13,000 kg	220 X 660 X 320 mm (50 pcs)
UPF21SN070	705 mm	700 mm	15,500 kg	220 X 760 X 320 mm (50 pcs)
UPF21SN085	846 mm	841 mm	9,200 kg	180 X 910 X 220 mm (25 pcs)
UPF21SN100	1005 mm	1000 mm	10,500 kg	180 X 1070 X 220 mm (25 pcs)
UPF21SN120	1205 mm	508 mm	12,500 kg	180 X 1260 X 220 mm (25 pcs)

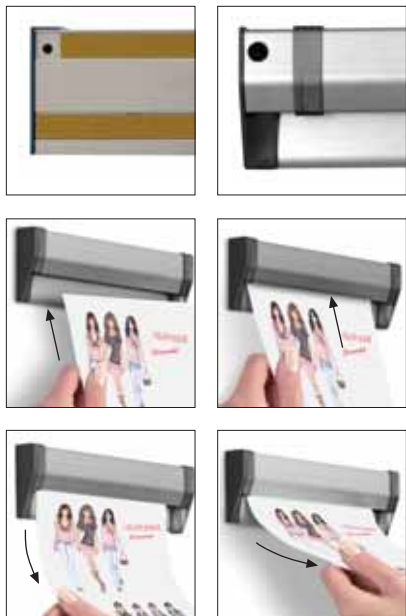

* W: Width H: Height D: Depth

Fastnote is a product which you can hang your papers, notes, pictures, photos without magnet or pin. It has a slim and compact design. Cylinders in the profile give possibility to hold paper easily inside. Suitable for agents, ateliers, hospitals, hotels, conference rooms, houses and offices... Standard colour is silver anodized. Different sizes and colours are available. You can assemble the product on the wall through fixing holes located on profile with screws and wall-plugs or you can apply anywhere with double sided tape.



 It is user friendly. Fixing set (screw and double sided tape) and manual comes with each product.

 Suitable for silk-screen printing max. letter height is 14 mm.

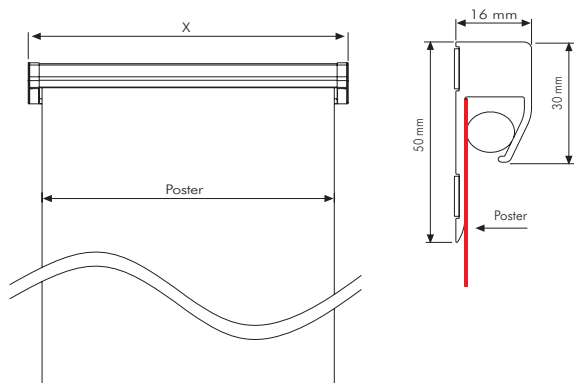

MATERIAL : Silver anodised aluminium			WEIGHT	PACKING SIZE
ARTICLE	EXTERNAL (x)	POSTER	WITH PACKING	*W X H X D
UFN000N031	334 mm	310 mm	8,000 kg	220 X 360 X 320 mm (50 pcs)
UFN000N050	529 mm	500 mm	12,900 kg	220 X 560 X 320 mm (50 pcs)
UFN000N058	604 mm	580 mm	14,400 kg	220 X 640 X 320 mm (50 pcs)
UFN000N088	904 mm	880 mm	11,000 kg	180 X 940 X 220 mm (25 pcs)
UFN000N100	1024 mm	1000 mm	12,000 kg	180 X 1060 X 220 mm (25 pcs)
UFN000N118	1204 mm	1180 mm	14,250 kg	180 X 1240 X 220 mm (25 pcs)
UFN000N150	1534 mm	1500 mm	18,000 kg	180 X 1560 X 220 mm (25 pcs)

* W:Width H: Height D: Depth



